



RDF302, RDF302.B



RDF302/VB

Flush-mounted room thermostats with RS485 Modbus communications RDF302, RDF302/VB, RDF302.B

Basic documentation

Contents

1.	About this document	4
1.1	Revision history	4
1.2	Reference documents.....	5
1.3	Before you start	5
1.3.1	Copyright.....	5
1.3.2	Quality assurance	5
1.3.3	Document use / request to the reader	5
1.4	Target audience, prerequisites	6
1.5	Glossary.....	6
2.	Summary	7
2.1	Types	7
2.2	Ordering	7
2.3	Functions.....	7
2.4	Integration via Modbus.....	8
2.5	Equipment combinations.....	9
2.6	Accessories	9
3.	Functions	10
3.1	Temperature control.....	10
3.2	Operating modes	11
3.2.1	Different ways to influence the operating mode	12
3.3	Room temperature setpoint.....	13
3.3.1	Description	13
3.3.2	Setting and adjusting setpoints	14
3.4	Applications overview	16
3.4.1	Applications for fan coil systems *).....	17
3.4.2	Applications for universal systems *).....	18
3.4.3	Applications for heat pump systems *)	19
3.5	Additional functions.....	20
3.6	Control sequences.....	23
3.6.1	Sequences overview (setting via parameter P01).....	23
3.6.2	2-pipe fan coil unit.....	24
3.6.3	2-pipe fan coil unit with electric heater.....	25
3.6.4	4-pipe fan coil unit.....	27
3.6.5	Chilled / heated ceiling and radiator applications	29
3.6.6	Compressor applications	29
3.6.7	Setpoints and sequences.....	30
3.7	Control outputs	32
3.7.1	Overview	32
3.7.2	Control outputs configuration (setting via DIP switches or Modbus commissioning tool).....	33
3.8	Fan control	34
3.9	Multifunctional input, digital input.....	37
3.10	Handling faults.....	39
3.11	Modbus RTU mode.....	40
3.11.1	Fault function on Modbus.....	40
3.12	Communication objects.....	41

3.12.1	Overview	41
3.12.2	Description of communication objects	42
3.13	Control parameters	47
3.13.1	Parameter setting via local HMI.....	47
3.13.2	Parameter setting / download via Modbus communication tool	47
3.13.3	Parameters of the "Service level"	48
3.13.4	Parameters of the "Expert level with diagnostics and test"	49
4.	Handling.....	51
4.1	Mounting and installation	51
4.2	Commissioning	52
4.3	Operation.....	53
4.4	Disposal	54
5.	Connection.....	55
5.1	Connection terminals	55
5.2	Connection diagrams	56
6.	Mechanical design.....	57
6.1	General	57
6.2	Dimensions.....	58
7.	Technical data.....	59

1. About this document

1.1 Revision history

Edition	Date	Changes	Section	Pages
1.6	2022-06-17	Add one more value of P06	3.12.2 3.13.3	44 48
1.5	2020-12-01	Update function code description	3.12.2	45-49
1.4	2020-02-21	Add product RDF302/VB related information	1.2 1.4 1.5 2.1 2.2 2.4 3.7.1 3.11 3.12.1 4.3 6.1	4 7 7 8 8 9 34 42 43 55 59
1.3	2018-12-04	Add product RDF302.B related information	1.1, 1.2 1.4, 1.5 2.1, 2.2 2.4 3.2 3.2.1 3.5 3.6.4 3.7.1 3.9 3.11, 3.11.1 3.12 3.12.2 3.13.4 4.1 4.3 5.1 6.1 7	4 6 7 8 12 13-14 21 28 33 38 41 42 46 51 52 54 56 58 61
1.2	2017-12-08	Update communication objects Add information about operating mode.	3.12.1 3.12.2 3.2 3.2.1 3.12.2	42 43-44 12 13 46
1.1	2014-10-09	As per new software update and compliance update, as well as other corrections	2.5 3.4 3.6 3.7.1 4.1 4.4 7	9 16 23 32 51 54 59
1.0	07,12.2011	First edition		

1.2 Reference documents

Subject	Ref	Doc No.	Description
Modbus Manual	[1]		MODBUS over serial line specification and implementation guide (http://www.modbus.org)
RDF302, RDF302/VB, RDF302.B Room Thermostat with Modbus Interface	[2]	CB1N3079	Data Sheet
	[3]	CB1B3079	Operating Instructions
	[4]	CB1M3079	Installation Instructions
SEZ50MB (RWD Modbus)	[5]	CB1N3099	Data Sheet
	[6]	CB1P3099	Basic Documentation

1.3 Before you start

1.3.1 Copyright

This document may be duplicated and distributed only with the express permission of Siemens, and may be passed only to authorized persons or companies with the required technical knowledge.

1.3.2 Quality assurance

This document was prepared with great care.

- The contents of this document is checked at regular intervals
- Any corrections necessary are included in subsequent versions
- Documents are automatically amended as a consequence of modifications and corrections to the products described

Please make sure that you are aware of the latest document revision date.

If you find lack of clarity while using this document, or if you have any criticisms or suggestions, please contact the Product Manager in your nearest branch office.

The addresses of the Siemens Regional Companies are available at www.buildingtechnologies.siemens.com.

1.3.3 Document use / request to the reader

Before using our products, it is important that you read the documents supplied with or ordered at the same time as the products (equipment, applications, tools, etc.) carefully and in full.

We assume that persons using our products and documents are authorized and trained appropriately and have the technical knowledge required to use our products as intended.

More information on the products and applications is available:

- On the intranet (Siemens employees only) at <https://workspace.sbt.siemens.com/content/00001123/default.aspx>
- From the Siemens branch office near you www.buildingtechnologies.siemens.com or from your system supplier
- From the support team at headquarters fieldsupport-zug.ch.sbt@siemens.com if there is no local point of contact

Siemens assumes no liability to the extent allowed under the law for any losses resulting from a failure to comply with the aforementioned points or for the improper compliance of the same.

1.4 Target audience, prerequisites

Product & sales managers, distributors, re-sellers & OEM customers who use RDF302, RDF302/VB and RDF302.B room thermostats in the RS485 Modbus RTU network.

Since Modbus protocol has been well known for years in the industry, this document will explain the operations related to RDF302, RDF302/VB and RDF302.B Modbus units. e.g. the unit setup, available settings and their applications. And, users should have the general knowledge of HVAC systems and local electrical installation regulations where RDF302, RDF302/VB and RDF302.B units are employed.

For reference documentation, see section 0.

1.5 Glossary

The inputs, outputs and parameters of an application can be influenced in various ways. These are identified by the following symbols in this document:

Term	Description
DTE	Data Terminal Equipment
Modbus master	A MODBUS device, which is able to access data in one or more connected MODBUS Slave
Modbus slave	A MODBUS device, which is able to respond to requests from a single MODBUS master
Pxx	Parameters of the device where xx = 00, 01, 02, etc.
RDF Modbus	The name of RDF302, RDF302/VB and RDF302.B providing RS485 Modbus communicative
RTU	Remote Terminal Unit = Standard MODBUS transmission mode

The communication objects of the RDF302, RDF302/VB and RDF302.B thermostats are described accordingly.

A list of the parameters is shown in section 3.13.

2. Summary

2.1 Types

Product no.	Stock no.	Operating voltage	Control outputs		Suitable conduit box	Color
			3-pos	ON/OFF		
RDF302	S55770-T238	AC 230 V	1 ¹⁾	2 ¹⁾	square	White
RDF302/VB	S55770-T428	AC 230 V	1 ¹⁾	2 ¹⁾	square	Black
RDF302.B	S55770-T416	AC 230 V	1 ¹⁾	2 ¹⁾	square	White

1) Selectable: ON/OFF or 3-position

2.2 Ordering

Product no.	Stock no.	Designation
RDF302	S55770-T238	Modbus Room thermostat
RDF302.B	S55770-T416	Basic Modbus room thermostat
RDF302/VB	S55770-T428	Modbus Room thermostat

For input and output difference between RDF302, RDF302/VB and RDF302.B, see [Connection terminals](#).

Order valve actuators separately.

2.3 Functions

Use

Fan coil units via ON/OFF outputs:

- 2-pipe system *
- 2-pipe system with electric heater
- 4-pipe system

Chilled / heated ceilings (or radiators) via ON/OFF outputs:

- Chilled / heated ceiling *
- Chilled / heated ceiling with electric heater
- Chilled / heated ceiling and radiator / floor heating

Compressors: via ON/OFF control

- 1-stage compressors in DX type equipment
- 1-stage compressors in DX type equipment with electric heater

* *with both ON/OFF or modulating control output*

The room thermostats are delivered with a fixed set of applications.

The relevant application is selected and activated during commissioning using one of the following tools:

- Local DIP switch and HMI
- Modbus commissioning tools

Features

- Operating modes: Comfort, Economy and Protection
- ON/OFF or 3-position control outputs (relay)
- Output for 3-speed or 1-speed fan
- Automatic or manual heating / cooling changeover

- Backlit display
- AC 230 V operating voltage

Functions

- Room temperature control via built-in temperature sensor or external room temperature / return air temperature sensor
- Changeover between heating and cooling mode (automatic via local sensor or Modbus, or manually)
- Selection of applications via DIP switches or commissioning tool.
- Select operating mode via operating mode button on the thermostat
- 1- or 3-speed fan control (automatically or manually)
- Display of current room temperature or setpoint in °C and/or °F
- Display of outdoor temperature or time of day via Modbus
- Minimum and maximum limitation of room temperature setpoint
- Key lock (automatically, manually or via Modbus)
- 2 multifunctional inputs, freely selectable for:
 - Operating mode switchover contact (keycard, window contact, etc.)
 - Sensor for automatic heating / cooling changeover
 - External room temperature or return air temperature sensor
 - Dew point sensor
 - Electric heater enable
 - Fault input
 - Monitor input for temperature sensor or switch state
- Advanced fan control function, e.g. fan kick, fan start, selectable fan operation (enable, disable or depending on heating or cooling mode)
- “Purge” function together with 2-port valve in a 2-pipe changeover system
- Reminder to clean fan filters
- Floor heating temperature limitation
- Reload factory settings for commissioning and control parameters
- RS 485 Modbus (terminals +, - and REF) for communication with Modbus compatible devices

2.4 Integration via Modbus

The RDF302, RDF302/VB and RDF302.B are communicative thermostat with Modbus open protocol on RTU (Remote Terminal Unit) mode enabling easy integration into BACS via RS-485.















The following Modbus functions are available:

- Central controls of room operating modes, setpoints, fan speed and fan mode
- Remote monitoring e.g. operating mode, control outputs, temperature sensor or switch, etc.
- Alarming, e.g. external fault contact, condensation, clean filter, etc.
- Outside temperature or time of day via bus displayed on thermostat
- Key lock

Engineering and commissioning can be done using...



- local DIP switches / HMI
- via Modbus commissioning tool

2.5 Equipment combinations

	Description	Product no.	Data sheet
	Cable temperature sensor or changeover sensor cable length 2.5 m NTC (3 kΩ at 25 °C)	 QAH11.1	1840
	Room temperature sensor NTC (3 kΩ at 25 °C)	 QAA32	1747
	Cable temperature sensor cable length 4 m NTC (3 kΩ at 25 °C)	 QAP1030/UFH	1854
	Condensation monitor / Dew point monitor	 QXA2601 / QXA2602 / QXA2603 / AQX2604	3302
ON / OFF actuators	Electromotoric ON / OFF actuator	 SFA21...	4863
	Electromotoric ON / OFF valve and actuator (only available in AP, UAE, SA and IN)	 MVI... / MXI...	A6V11251892
	Zone valve actuator (only available in AP, UAE, SA and IN)	 SUA...	4832
	Thermal actuator (for radiator valves)	 STA23...	4884
	Thermal actuator (for small valves 2.5 mm)	 STP23...	4884
3-position actuators	Electrical actuator, 3-position (for radiator valves)	 SSA31...	4893
	Electrical actuator, 3-position (for 2- and 3-port valves / V...P45)	 SSC31...	4895
	Electrical actuator, 3-position (for small valves 2.5 mm)	 SSP31...	4864
	Electrical actuator, 3-position (for small valves 5.5 mm)	 SSB31...	4891
	Electrical actuator, 3-position (for small valves 5.5 mm)	 SSD31...	4861
	Electromotoric actuator, 3-position (for small valves 5.5 mm)	 SQS35...	4573

- Note:** For the maximal number of actuators in parallel, refer to information in the data sheets of the selected actuators and to this list, depending on which value is lower:
- Parallel operation of max 6 SS... actuators (3-pos) is possible.
 - Parallel operation of max 10 ON / OFF actuators is possible.
 - Parallel operation of SQS35 is not possible.

2.6 Accessories

Description	Product no. / SSN	Data sheet
Changeover mounting kit (50 pcs / package)	 ARG86.3	N3009
Plastic mounting spacer for flush mount thermostats to increase the headroom in the conduit box by 10 mm	 ARG70.3	N3009

3. Functions

3.1 Temperature control

General note: Parameters

Setting of the control parameters (P01, etc., mentioned throughout the document) is described in section 3.13.

Temperature control

The thermostat acquires the room temperature via built-in sensor, external room temperature sensor (QAA32), or external return air temperature sensor (QAH11.1), and maintains the setpoint by delivering actuator control commands to heating and/or cooling equipment. The following control outputs are available:

- ON/OFF control (2-position)
- Modulating PI/P control with 3-position control output (only for 2-pipe applications)

The switching differential or proportional band is 2 K for heating mode and 1 K for cooling mode (adjustable via parameters P30 and P31).

The integral action time for modulating PI control is 5 minutes (adjustable via parameter P35).

Display





The display shows the acquired room temperature or the Comfort setpoint, selectable via parameter P06. The factory setting displays the current room temperature. Use parameter P04 to display the room temperature or setpoint in °F rather than °C as needed.



Room temperature

The acquired room temperature (internal or external sensor) is also available as information on the Modbus.



- With automatic changeover or continuous heating / cooling, symbols  /  indicate that the system currently heats or cools (heating or cooling output is activated).
- With manual changeover (P01 = 2), symbols  /  indicate that the system currently operates in heating or cooling mode. Thus, the symbols are displayed even when the thermostat operates in the neutral zone.

Concurrent display of °C and °F

Concurrent display of the current temperature or setpoint in °C and °F (parameter P07 = 1) is possible on the thermostats.



Outside temperature

The outside temperature can be displayed on the room thermostat by setting parameter P07 = 2. This temperature value has only information character which comes from the master device in the Modbus network.



Time of day

Time of day via Modbus can be displayed on the room thermostat by setting parameter P07 = 3 or 4. The display format is either in 12- or in 24-hour format. The information can be received from a master device in the Modbus network.

3.2 Operating modes

The thermostat's operating mode can be influenced in different ways. e.g. operating mode button, switch over contact, Modbus, etc. Specific heating and cooling setpoints are assigned to each operating mode.



Room operating mode:
Preselection

The operating mode can be selected via Modbus.

- If a bus command is received via MODBUS for either COMFORT or ECONOMY operating mode, the symbol of the selected operating mode will be displayed.
i.e. either COMFORT or ECONOMY symbol only
- If a bus command is received for PROTECTION mode, the AUTO TIMER symbol (Auto) will be displayed and all key buttons will be de-activated.
i.e. both PROTECTION and AUTO TIMER symbols

 Room
operating mode: State

The thermostat returns the effective room operating mode on the Modbus.

The following operating modes are available:

Comfort 

In Comfort mode, the thermostat maintains the Comfort setpoint. This setpoint can be defined via parameters P8, P9 and P10.

Also, it can be locally adjusted via the +/- buttons or remotely via Modbus. In Comfort mode, the fan can be set to automatic or manual fan speed: Low, medium or high.

Economy 

A preset setpoint in economy mode can be defined via parameters P11 and P12. The thermostat switches to Economy mode when...



Window state

- the operating mode button is pressed (only possible if parameter P02 is set to 2)
- Economy is sent via Modbus
- an operating mode switchover contact (e.g. keycard contact presence detector, window contact) is active.
The contact can be connected to multifunctional input X1, X2.
Set parameter P38 / P40 to 3 (P02 is irrelevant) *)
- "Window state" is sent via Modbus

Note: *) Operating mode switchover: *Only one input source must be used, either local input X1/X2 or Modbus. User operations are ineffective and "OFF" is displayed if the operating mode switchover contact is active, or if "Window state" is sent via Modbus. The parameters related to X1 and X2 input functions are not applicable to RDF302.B.*

Protection 

In Protection mode, the system is...

- protected against frost (factory setting 8 °C, can be disabled or changed via P65)
- protected against overheating (factory setting OFF, can be enabled or changed via P66)

No other operating mode can be selected locally if Protection mode is commanded via Modbus.  is displayed.

3.2.1 Different ways to influence the operating mode





Priority of operating mode interventions

The operating mode can be influenced by different interventions. The table below shows the priorities of different interventions. (i.e. lower number higher priority)

Priority	Description	Remark
①	Commissioning	In parameter setting mode (highest priority), you can always command an operating mode independent of all other settings or intervention via Modbus and local input. If P02 changed by Modbus, the operating mode will jump to Protection mode, in all cases, after the update.
②	Operating mode switchover contact	If the contact is closed, the operating mode changes to Economy. This overrides the operating mode on the thermostat.
②	"Window state" via Modbus	"Window state" sent via Modbus has the same effect as the operating mode switchover contact.
<i>Note: Only one input source must be used, either local input X1/X2 or Modbus. RDF302.B does not have inputs X1 and X2.</i>		
③	Operating mode via Modbus	The operating mode can be changed via Modbus Note: Operating mode button is disabled if Protection mode is commanded via Modbus. If a bus command is received via MODBUS for either COMFORT or ECONOMY operating mode, the symbol of the selected operating mode will be displayed. i.e. either COMFORT or ECONOMY symbol only If a bus command is received for PROTECTION mode, the AUTO TIMER symbol () will be displayed and all key buttons will be de-activated. i.e. both PROTECTION and AUTO TIMER symbols
④	Operating mode button	The user can switch the operating mode via the operating mode button unless a key lock command received from the Modbus before.
<i>Note: Higher priority commands can override the lower priority's command. If operating mode is set via Modbus, the unit will indicate by flashing "OFF" when OpMode button pressed by users.</i>		

Availability of Economy mode

The operating mode can be selected locally via the operating mode button.
The behavior of the operating mode button (user profile) can be defined via parameter P02, factory setting is P02 = 1.

P02	Without time schedule	Description
1	 → 	<ul style="list-style-type: none"> Switching manually between 2 modes, Economy is not available (factory setting) Suited for hotel guest rooms or commercial buildings.
2	 →  → 	<ul style="list-style-type: none"> Switching manually between 3 modes Suited for homes and rooms where manual switching to Economy mode is desired

Operating mode switchover contact (window contact)

The thermostat can be forced into Economy mode (e.g. when a window is opened, when a presence detector signals "no one present", when the keycard of a hotel room is withdrawn, etc). The contact can be connected to multifunctional input X1, X2. Set parameter P38, P40 to 3.



Room operating mode: Window State

The function is also available via the Modbus signal "Window state",

Note: Only one input source must be used, either local input X1/X2 or Modbus. User operations are ineffective and "OFF" is displayed if the operating mode switchover contact is active, or if "WindowContact" is sent via Modbus. RDF302.B does not have inputs X1 and X2.

3.3 Room temperature setpoint

3.3.1 Description

Comfort mode ☀

The factory setting for the Comfort basic setpoint is **21 °C** and can be changed in the thermostat's EEPROM via parameter P08 or via Modbus with communication object "Comfort basic setpoint". The last intervention always wins.

The Comfort setpoint can be adjusted via the +/- buttons, or via Modbus from a remote device like a touch panel or master unit, etc. The last intervention always wins.

Temporary setpoint

If the "Temporary setpoint" function is enabled via parameter P69, the Comfort setpoint adjusted via the + / - buttons or via Modbus is set back to the Comfort basic setpoint stored in P08 when the operating mode changes.

Setpoint limitation

For energy saving purposes, the setpoint setting range can be limited to minimum (P09) and maximum (P10).

P09 < P10

- If the minimum limit **P09 is set lower** than the maximum limit P10, both heating and cooling are adjustable between these 2 limits

P09 ≥ P10

- For heating **or** cooling applications (e.g. 2-stage):
 - The setting range in cooling mode is from **P09...40 °C** in place of 5...40 °C
 - The setting range in heating mode is from **5...P10 °C** in place of 5...40 °C
- For heating **and** cooling applications (e.g. 4-pipe):
 - The cooling and heating setpoint are adjustable
 - The setting range in cooling mode is from **P09...40 °C** in place of 5...40 °C
 - The setting range in heating mode is from **5...P10 °C** in place of 5...40 °C

Examples	2-pipe heating OR cooling	4-pipe heating AND cooling
P09 < P10	<p>Cooling setpoint adjustable 18...25 °C Heating setpoint adjustable 18...25 °C</p>	<p>Cooling setpoint adjustable 18...25 °C Heating setpoint adjustable 18...25 °C</p>

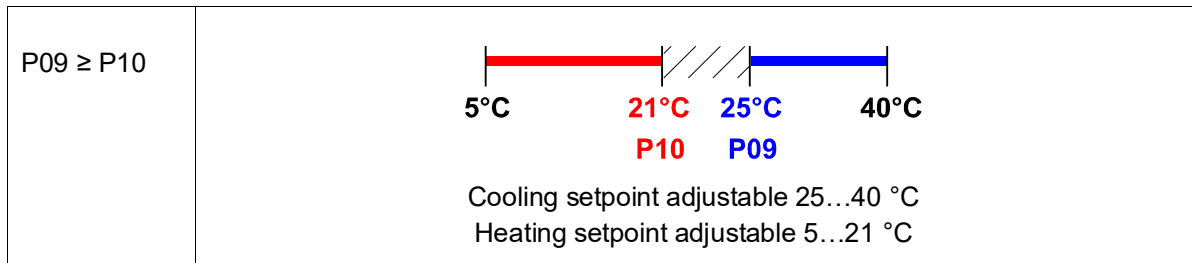

Economy mode ☺

Use control parameters P11 and P12 to adjust the Economy mode setpoints. The heating setpoint is factory-set to **15 °C**, and the cooling setpoint to **30 °C**.

Protection mode ⏻

Use control parameters P65 and P66 to adjust the Protection mode setpoints. The heating setpoint is factory-set to **8 °C** (frost protection) and to **OFF** for cooling.

Caution ⚠

If a setpoint (Economy or Protection) is set to OFF, the thermostat does not control the room temperature in the corresponding mode (heating or cooling). This means no protective heating or cooling function and thus risk of frost in heating mode or risk of over-temperature in cooling mode!

The Economy setpoints are accessible at the service level (P11, P12); the Protection setpoints at the expert level (P65, P66).

3.3.2 Setting and adjusting setpoints

Room temperature setpoints can be

- set during commissioning
- adjusted during runtime



Room temperature:
Comfort setpoint

The source can be via

- local HMI
- a Modbus commissioning tool
- a Modbus master unit

The thermostat stores the setpoints

- in EEPROM in the form of parameters

The table below shows the interrelations:

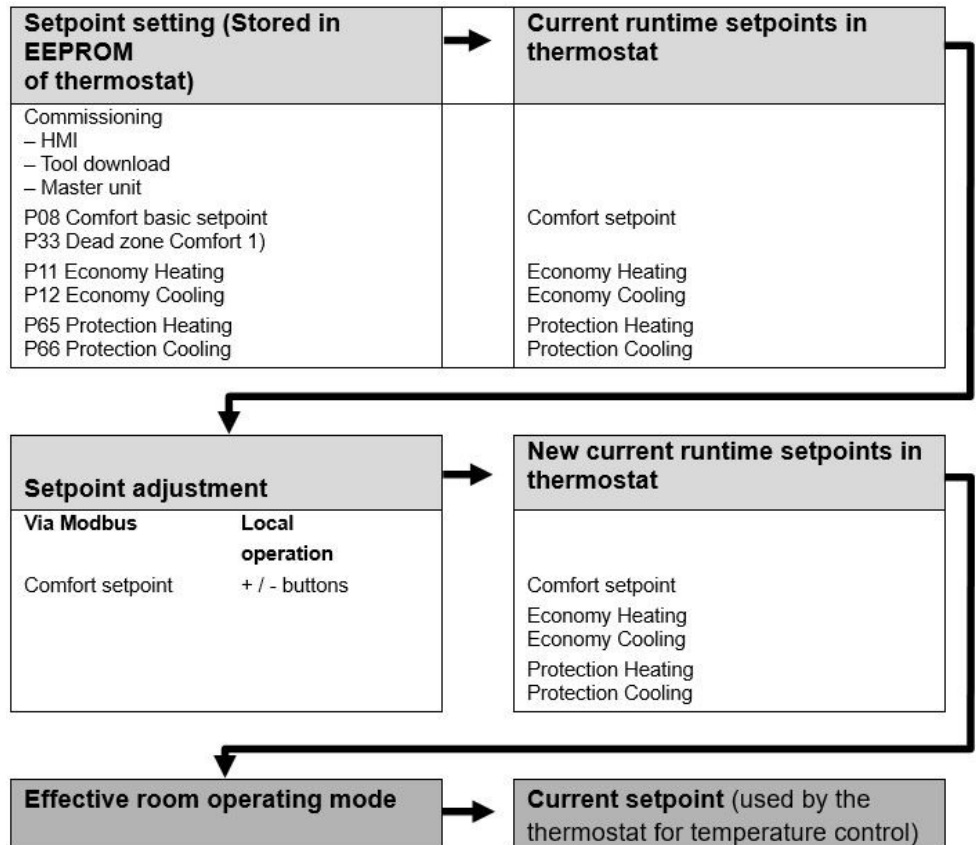

1) Only required for heating AND cooling applications (see section 3.6.7)



Room temperature:

Current setpoint

General notes:

The current setpoint (used by the thermostat for temperature control) is available on the Modbus for use in the central control unit.

- Changes via the local HMI or via tool have the same priority (last always wins)
- Setting the Comfort basic setpoint will reset the runtime Comfort setpoint to the basic setpoint

Notes on setpoint adjustment

- The resulting (current) setpoint heating and cooling is limited by the Protection setpoint; if Protection setpoint is OFF, then minimum 5 °C and maximum 40 °C are used
- The resulting setpoints for cooling and heating of the same operating mode have a minimum distance of 0.5 K between them

3.4 Applications overview

The thermostats support the following applications, which can be configured using the DIP switches inside the front panel of the unit or a Modbus commissioning tool.

Remote configuration

All DIP switches need to be set to **OFF** (factory setting) to select an application via commissioning tool.

Remote configuration , via commissioning tool (factory setting)	DIP switches 
--	--

See also...

- section 3.4.1 “Applications for fan coil systems”
- section 3.4.2 “Applications for universal systems”
- section 3.4.3 “Applications for heat pump systems”
- section 3.6.5 “Universal applications”
- section 3.6.6 “Compressor applications”.

3.4.1 Applications for fan coil systems *)

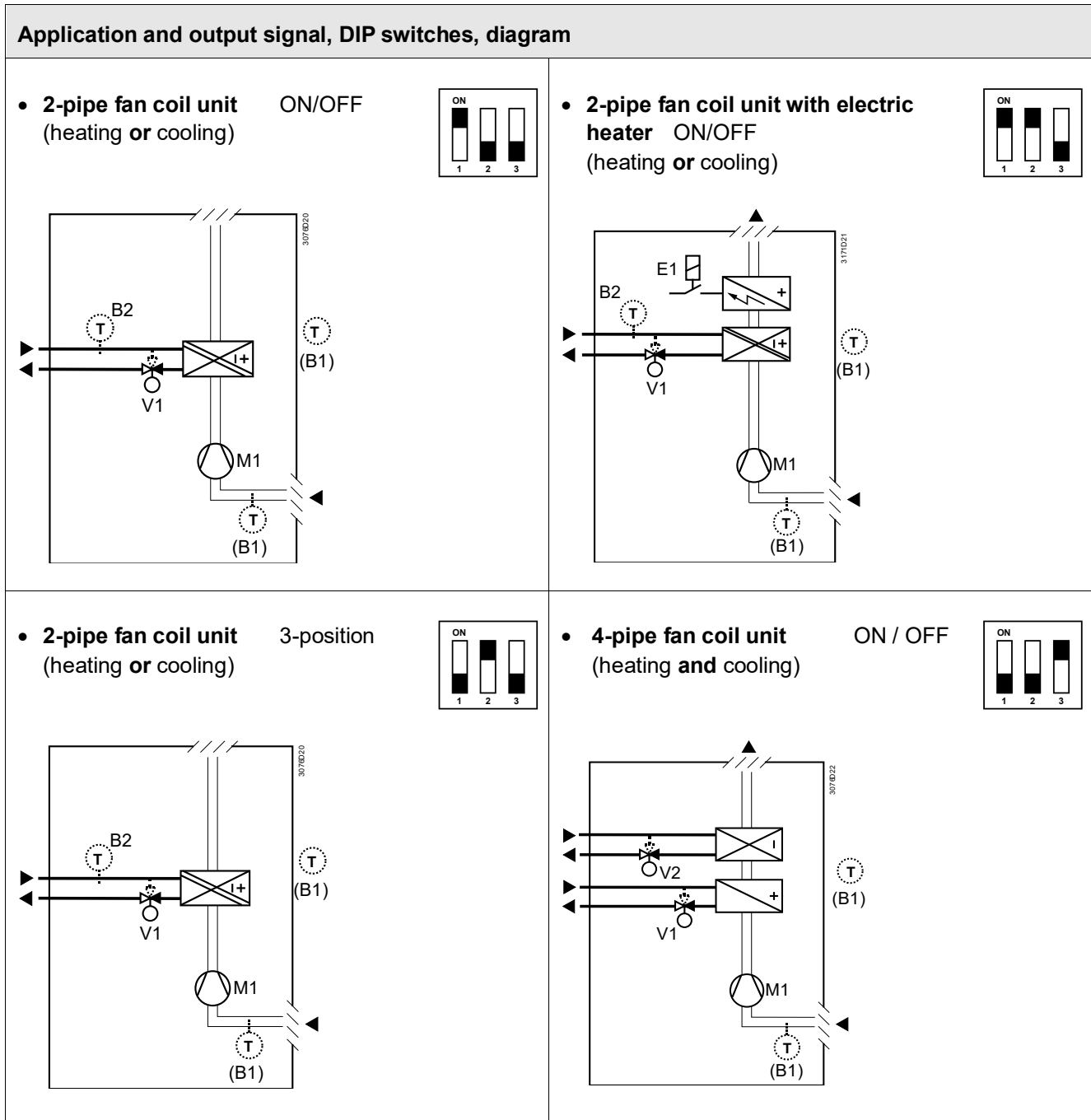

V1 Heating or heating / cooling valve actuator

V2 Cooling valve actuator

E1 Electric heater

B1 Return air temperature sensor or external room temperature sensor (optional)

B2 Changeover sensor (optional)

M1 3- or 1-speed fan

*) RDF302.B does not have inputs X1 and X2, so sensor B1 and B2 are not included in RDF302.B application.

3.4.2 Applications for universal systems *)

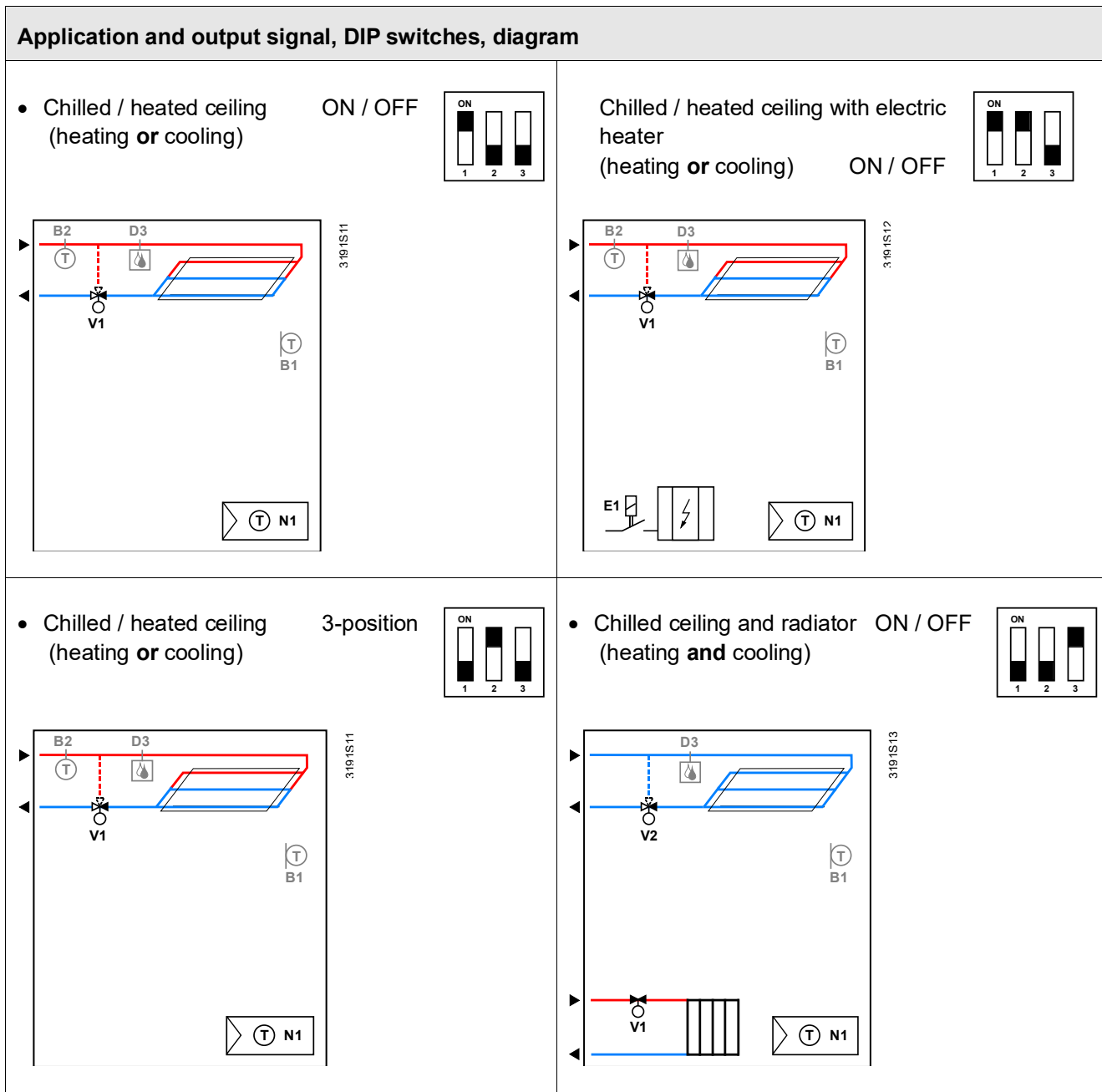

V1 Heating or heating / cooling valve actuator

B1 Return air temperature sensor or external room temperature sensor (optional)

V2 Cooling valve actuator

B2 Changeover sensor (optional)

E1 Electric heater

D3 Dewpoint sensor

*) RDF302.B does not have inputs X1 and X2, so sensor B1 and B2 are not included in RDF302.B application.

3.4.3 Applications for heat pump systems *)

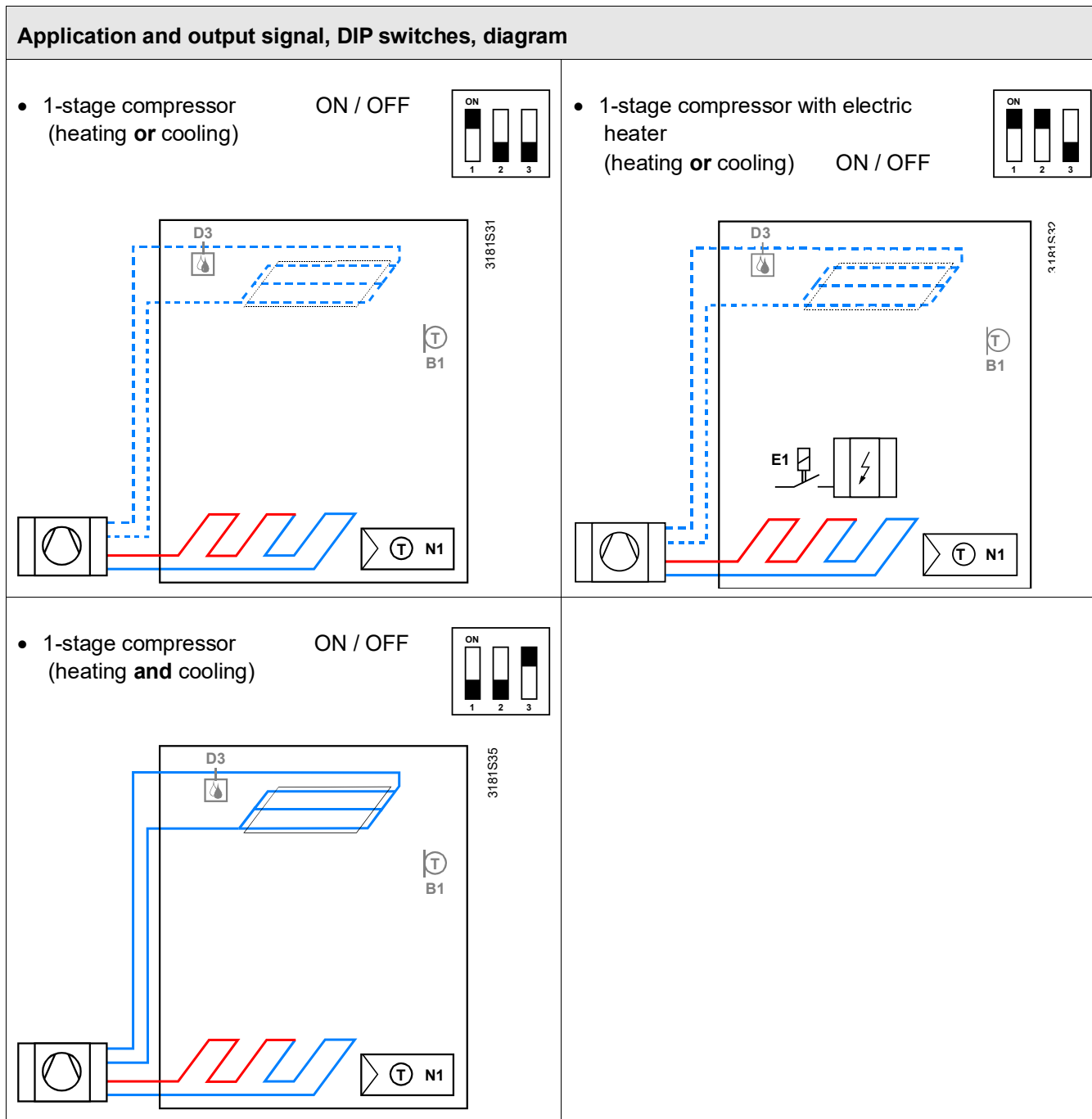

N1 Thermostat
Terminal Y11: Heating or heating / cooling
Terminal Y21: for cooling (H & C)
E1 Electric heater

B1 Return air temperature sensor or external room temperature sensor (optional)

D3 Dewpoint sensor

*) RDF302.B does not have inputs X1 and X2, so sensor B1 and B2 are not included in RDF302.B application.

3.5 Additional functions

Heating / cooling changeover via Modbus



Heating/cooling changeover

Automatic heating / cooling changeover via changeover sensor

The heating / cooling changeover information can be received via Modbus. This is only possible if the control sequence is set to automatic heating / cooling changeover (parameter P01 = 3) and no local input X1, X2 is assigned with this function.

Note: RDF302.B does not have inputs X1 and X2.

In the absence of the required information (e.g. due to problems with data communication, power failure, etc.), the thermostat operates in the last valid room operating mode (heating or cooling).

If a cable temperature sensor (QAH11.1 + ARG86.3) is connected to X1 / X2, and parameter P38 / P40 is =2, the water temperature acquired by the changeover sensor is used to change over from heating to cooling mode, or vice versa.

- When the **water temperature** is above 28 °C (adjustable via parameter P37), the thermostat changes over to **heating mode**.
It stays in heating mode until the temperature falls below 16°C (adjustable via parameter P36)
- When the **water temperature** is below 16 °C (P36), the thermostat changes over to **cooling mode**.
It stays in cooling mode until the temperature rises above 28°C (P37).
- If the water temperature is between the 2 changeover points immediately after power-up (inside the hysteresis), the thermostat starts in previous mode.

The water temperature is acquired at 30-second intervals and the operating state is updated accordingly.

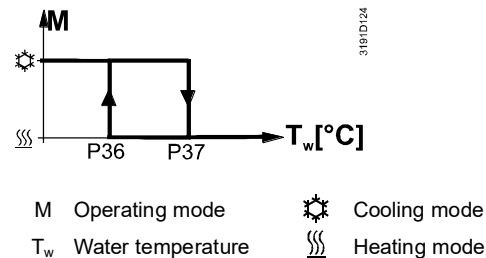

Changeover switch

The QAH11.1 cable temperature sensor for automatic heating / cooling changeover can be replaced by an external switch for manual, remote changeover:

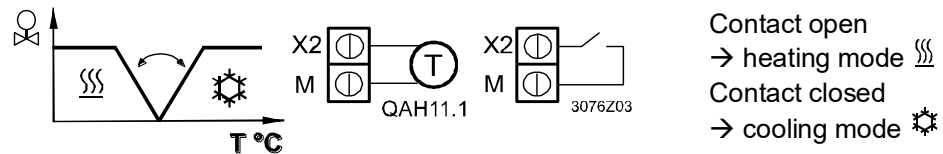

The sensor or switch can be connected to input terminal X2 or X1, depending on the commissioning of the inputs (P38, P40).

See also section 3.9 “Multifunctional input”.

Manual heating / cooling changeover

- Manual heating / cooling changeover means selection via changeover button on the thermostat by repeatedly pushing the button until the required mode is shown on the display (automatic changeover is done via an external sensor / switch connected to X1, X2, or D1)
- If manual heating / cooling changeover is commissioned (P01 = 2), then heating / cooling mode cannot be changed via changeover sensor / switch; it will remain in the last mode as selected locally via button.

External / return air temperature sensor	<p>The thermostat acquires the room temperature via built-in sensor, external room temperature sensor (QAA32), or external return air temperature sensor (QAH11.1) connected to multifunctional input X1 or X2.</p> <p>Inputs X1 or X2 must be commissioned accordingly. See section 3.9 “Multifunctional input”.</p>
Purge function	<p>The changeover sensor ensures changeover from heating to cooling mode based on the acquired water temperature. We recommend activating the “Purge” function (parameter P50) with 2-port valves. This function ensures correct acquisition of the medium temperature even if the 2-port valve is closed for an extended period of time. The valve is then opened for 1 to 5 minutes (adjustable) at 2-hour intervals during off hours.</p>
Caution 	<p>The “Purge” function (parameter P50) must be disabled if the thermostat is used in compressor-based applications.</p>
Avoid damage from moisture	<p>In very warm and humid climates, the fan can be run periodically or continuously at a low fan speed (e.g. in empty apartments or shops) in Economy mode by setting parameter P61, in order to avoid damage from moisture due to lack of air circulation. See also section 3.8 “Fan control”, under “Fan kick function”.</p>
Minimum output ON-time / OFF-time	<p>Limit the ON/OFF switching cycle to protect the HVAC equipment, e.g. compressor and reduce wear and tear. The minimum output on-time and off-time for 2-position control output can be adjusted from 1 to 20 minutes via parameters P48 and P49. The factory setting is 1 minute.</p> <p>Readjusting the setpoint or heating / cooling mode changeover immediately results in calculation of the output state; the outputs may not hold the minimum 1-minute ON/OFF time.</p> <p>If parameter P48 or P49 is set to above 1 minute, the minimum ON/OFF time for the control output is maintained as set, even if the setpoint or changeover mode is readjusted.</p>
Floor heating / Floor cooling	<p>All heating sequences can also be used for floor heating.</p> <p>You can use fan coil unit heating / cooling sequences for floor heating or cooling by disabling the fan via parameter P52.</p>
Floor temperature limitation function	<p>The floor temperature should be limited for 2 reasons: Comfort and protection of the floor.</p> <p>The floor temperature sensor, connected to multifunctional input X1 or X2, acquires the floor temperature. If the temperature exceeds the parameterized limit (parameter P51), the heating valve is fully closed until the floor temperature drops to a level 2 K below the parameterized limit.</p> <p>This function is factory-set to OFF (disabled).</p> <p>Input X1 or X2 must be commissioned accordingly (P38 or P40 = 1).</p> <p>See section 3.9 “Multifunctional input”.</p>
Recommended values for P51:	<p>Living rooms: Up to 26 °C for long-time presence, up to 28 °C for short-time presence.</p> <p>Bath rooms: Up to 28 °C for long-time presence, up to 30 °C for short-time presence.</p>

The table below shows the relation between parameter, temperature source and temperature display:

Parameter P51	External temp. sensor available	Source for display of room temperature	Output control according to	Floor temp. limit function
OFF	No	Built-in sensor	Built-in sensor	Not active
OFF	Yes	External temp. sensor	External temp. sensor	Not active
10...50 °C	No	Built-in sensor	Built-in sensor	Not active
10...50 °C	Yes	Built-in sensor	Built-in sensor + limit by external sensor	Active

The “Floor temperature limitation” function influences the outputs listed in the table below:

Application	Output Y11	Output Y21	“Floor temp. limit” function has impact on			Remark
			Heating (P01 = 0/2/3)	Cooling (P01 = 1/2/3)	Heat. and cool (P01 = 4)	
2-pipe	H/C valve		Y11	N/A		
2-pipe & el heater	H/C valve	El heater	Y21	Y21 *)		Only el heater
4-pipe	Heating valve	Cooling valve	Y11	N/A	Y11	

*) If P13 = ON → electric heater in cooling mode

Note Either floor temperature sensor or external room temperature sensor can be used.

Dew point monitoring

Dew point monitoring is essential to prevent condensation on the chilled ceiling (cooling with fan disabled, parameter P52). It helps avoid associated damage to the building.

A dew point sensor with a potential-free contact is connected to multifunctional input X1 or X2. If there is condensation, the cooling valve is fully closed until no more condensation is detected, and the cooling output is disabled temporarily.



Fault state
Fault information

The condensation symbol “ \odot ” is displayed during temporary override and the fault “Condensation in room” will be sent via Modbus.

The input must be commissioned accordingly (P38, P40).

See section 3.9 “Multifunctional input”.

Key lock

Manual “key lock” function is enabled by parameter P14 (0=Disabled, 1=Auto lock, 2=Manual lock).

When P14=2, press operating mode button \odot for 5 seconds to lock or unlock all the buttons. If “Auto lock” is configured (P14=1), the thermostat will automatically lock all the buttons 10 seconds after the last adjustment and the way to unlock the buttons is the same as per manual lock.



Key lock command

The key lock command from the Modbus has higher priority to execute. Users are not able to change the operating mode by pressing the key button on the unit to release the key lock unless an unlock command received from the Modbus.

The key lock command from the Modbus provides several levels of functions:

- A = Lock all buttons
- B = Lock operating mode button only
- C = Lock fan button only
- D = Lock temperature adjusting buttons (+ & -) only.
- E = Unlock

3.6 Control sequences

3.6.1 Sequences overview (setting via parameter P01)

The main control sequence (i.e. the water coil sequence of the fan coil unit) can be set via **parameter P01**.

The following sequences can be activated in the thermostats (each without or with auxiliary heating).

The available sequences depend on the application (selected via DIP switch, see section 3.4).

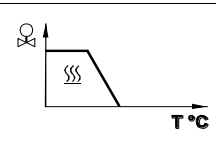
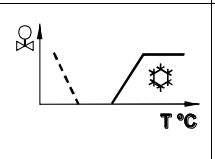
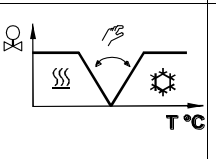
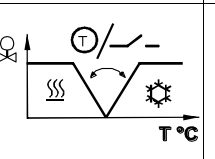
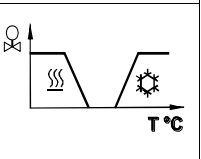
Parameter	P01 = 0	P01 = 1	P01 = 2	P01 = 3	P01 = 4
Sequence					
Available for basic application ¹⁾ :	Heating	Cooling ↘ = heating sequence for el. heater	Manually select heating or cooling sequence (using the button on the thermostat)	Automatic heating / cooling changeover via external water temperature sensor or remote switch	Heating and cooling sequence, i.e. 4-pipe
2-pipe, 2-pipe & el heater	✓	✓	✓	✓	
4-pipe			✓ 2)	✓ 2)	✓

Notes: 1) For chilled / heated ceiling and radiator applications, see section 3.6.5; for compressor applications, see section 3.6.6

2) For manual and automatic changeover with 4-pipe applications, see section 3.6.4:

- 4-pipe **manual** changeover (P01 = 2) means activating either cooling or heating outputs
- 4-pipe **automatic** changeover (P01 = 3) means swapping the control outputs according to a heating / cooling sensor or remote switch ("main and secondary" application), see section 3.6.4

For the relation between setpoints and sequences, see section 3.6.7.

3.6.2 2-pipe fan coil unit

On 2-pipe applications, the thermostat controls a valve in heating / cooling mode with changeover (automatically or manually), heating only, or cooling only. Cooling only is factory-set (P01 = 1).

ON/OFF control

Control sequence
ON/OFF output

The diagrams below show the control sequence for 2-position control.

Heating mode

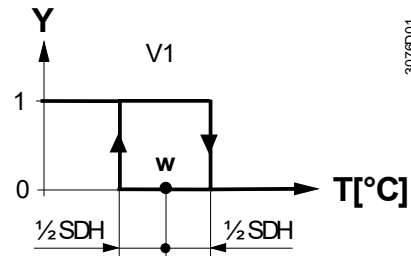

3076D01

Cooling mode

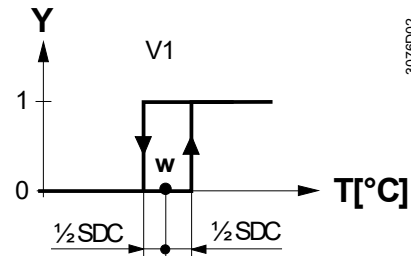

3076D02

T[°C] Room temperature

w Room temperature setpoint

V1 Control command "Valve" or "Compressor"

SDH Switching differential "Heating" (P30)

SDC Switching differential "Cooling" (P31)

Modulating control: 3-position

Control sequence
modulating output

The diagrams below show the control sequence for modulating PI control.

Heating mode

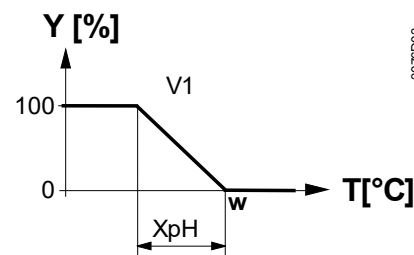

3076D03

Cooling mode

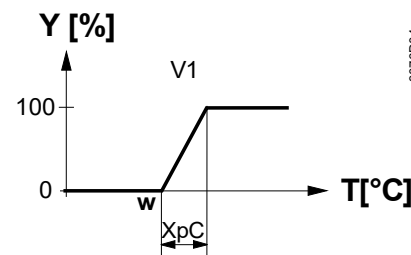

3076D04

T[°C] Room temperature

w Room temperature setpoint

V1 Control command "Valve"

XpH Proportional band "Heating" (P30)

XpC Proportional band "Cooling" (P31)

Note: The diagrams only show the PI thermostat's proportional part.

Setting the sequence and the control outputs

Refer to sections 3.4 "Applications", 3.6.1 "Sequences", and 3.7 "Outputs".

3.6.3 2-pipe fan coil unit with electric heater

Heating or cooling with auxiliary heater	<p>On 2-pipe applications with electric heater, the thermostat controls a valve in heating / cooling mode with changeover, heating only, or cooling only plus an electric heater.</p> <p>Cooling only is factory-set (P01 = 1) with enabled electric heater (P13).</p>
Electric heating, active in cooling mode	<p>In cooling mode, the valve receives an OPEN command if the acquired temperature is above the setpoint.</p> <p>The electric heater receives an ON command if the acquired room temperature drops below “setpoint” minus “dead zone” (= setpoint for electric heater) while the electric heater is enabled (parameter P13 = ON).</p> <p>Note: “Setpoint for electric heater” is limited by parameter “Maximum setpoint for Comfort mode” (P10).</p>
Electric heating in heating mode	<p>In heating mode, the valve receives an OPEN command if the acquired temperature is below the setpoint. The electric heater is used as an additional heating source when the heating energy controlled by the valve is insufficient.</p> <p>The electric heater receives an ON command, if the temperature is below “setpoint” minus “setpoint differential” (= setpoint for electric heater).</p>
Electric heating and manual changeover	<p>The electric heater is active in heating mode only and the control output for the valve is permanently disabled when manual changeover is selected (P01 = 2).</p>
Digital input “Enable electric heater”	<p>Remote enabling / disabling of the electric heater is possible via input X1 or X2 for tariff regulations, energy savings, etc.</p> <p>Input X1 or X2 must be commissioned accordingly (parameters P38, P40). See section 3.9 “Multifunctional input”.</p>



Enable electric heater

The electric heater can also be enabled / disabled via Modbus.

Note: If “Enable electric heater” input is used via Modbus, then the function **must not** be assigned to a local input X1 or X2.



Caution An electric heater must always be protected by a safety limit thermostat!

ON/OFF control

Control sequence
ON/OFF output

The diagrams below show the control sequence for 2-position.

Heating mode

(automatic changeover = heating or heating only)

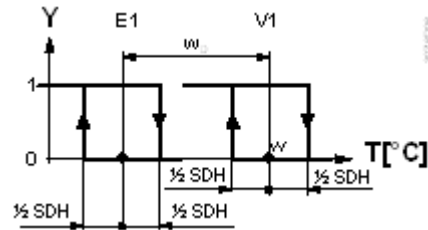

Cooling mode

(man. / auto. changeover = cooling or cooling only)

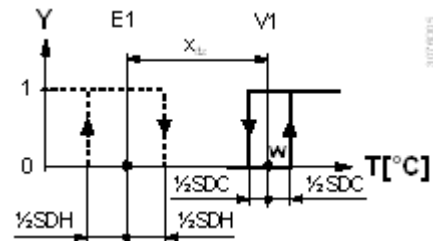

Heating mode with manual changeover (P01 = 2) (manual changeover = heating)

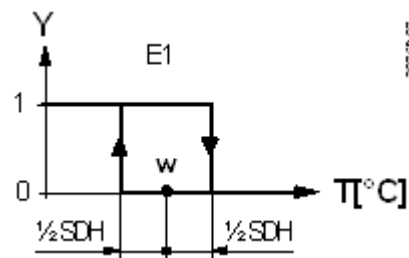

T[°C] Room temperature

W Room temperature setpoint

V1 Control command "Valve" or "Compressor"

E1 Control command "Electric heater"

SDH Switching differential "Heating" (P30)

SDC Switching differential "Cooling" (P31)

X_{dz} Dead zone (P33)

w_D Setpoint differential (P34)

Note: The diagrams only show the PI thermostat's proportional part.

Setting the sequence and the control outputs

Refer to sections 3.4 "Applications", 3.6.1 "Sequences", and 3.7 "Outputs".

3.6.4 4-pipe fan coil unit

Heating and cooling

On 4-pipe applications, the thermostat controls 2 valves in heating and cooling mode, heating / cooling mode by manual selection, or heating and cooling mode with changeover. Heating and cooling mode (P01 = 4) is factory-set.

4-pipe application with manual changeover

The heating or cooling output can be released via operating mode button if parameter P01 is set to Manual (P01 = 2).

"Main and secondary" application (4-pipe with changeover)

If parameter P01 is set to changeover (P01 = 3), the heating and cooling output is swapped according to the input state of the changeover sensor / switch input (see automatic heating and cooling changeover sensor in section 3.5). This mode is used for the so-called "Main and secondary" application. This is a 4-pipe fan coil unit system with different capacities of the 2 coils. The water circuit is changed to optimize the energy exchange depending on the season (summer / winter):

- Winter: Large coil (V1) for heating, small coil (V2) for cooling
- Summer: Large coil (V1) for cooling, small coil (V2) for heating

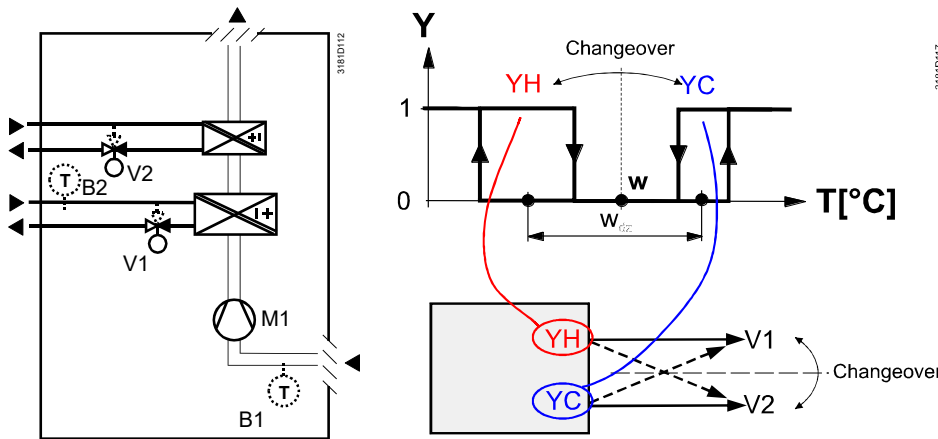

Note:
This example shows ON/OFF control; for modulating control, connect the appropriate output terminals

- Notes:
- The parameter for the heating and cooling changeover sensor (B2 in the above diagram) must be set to 2 (X1 or X2, P38 or P40)
 - The thermostat assumes winter operation when $B2 > P37$ (factory setting 28 °C)
 - The thermostat assumes summer operation when $B2 < P36$ (factory setting 16 °C)
 - RDF302.B does not have inputs X1 and X2.

ON/OFF control

The diagrams below show the control sequence for 2-position control.

Heating mode with manual selection
(P01=2) or
for P09 >= P10 in heating sequence *)

Cooling mode with manual selection
(P01=2) or
for P09 >= P10 in cooling sequence *)

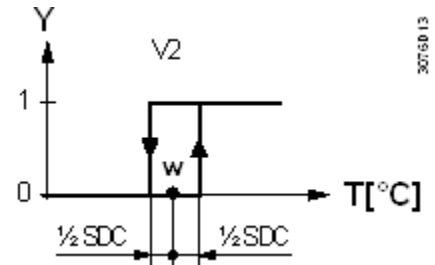
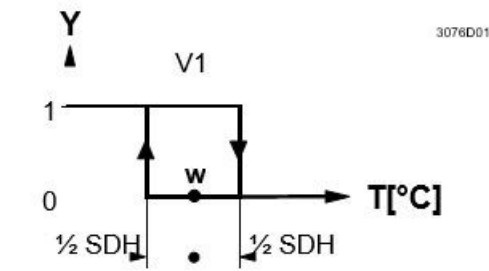

Heating and cooling mode (P01 = 04)

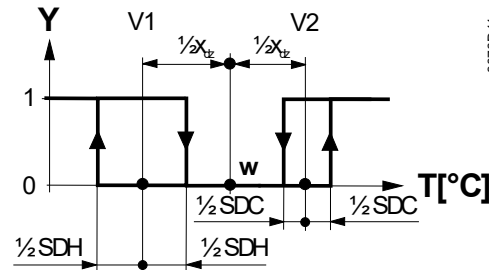

- T[°C] Room temperature
- w Room temperature setpoint
- V1 Control command "Valve" or "Comp." (H)
- V2 Control command "Valve" or "Comp." (C)
- SDH Switching differential "Heating" (P30)
- SDC Switching differential "Cooling" (P31)
- X_{dz} Dead zone (P33)

Note: The diagrams only show the PI thermostat's proportional part.

Setting the sequence and the control outputs

Refer to sections 3.4 "Applications", 3.6.1 "Sequences", and 3.7 "Outputs".

3.6.5 Chilled / heated ceiling and radiator applications

For chilled / heated ceiling and radiator,

- set the corresponding basic application
- disable the fan (P52)

The following applications are available:

Application for chilled / heated ceiling, radiator	Set basic application	See section	Sequences
Chilled / heated ceiling with changeover	2-pipe	3.6.2	H (\) C (/)
Chilled / heated ceiling & el heater (cooling only: disable el heater via P13)	2-pipe and electric heater	3.6.3	El H + H (A \) El H + C (A /) C (/)
Chilled ceiling and radiator	4-pipe	3.6.4	H + C (\ /)

3.6.6 Compressor applications

For compressor applications,

- set the corresponding basic application
- disable the fan (P52) or set the fan speed (P53)

The following applications are available:

Application for compressor	Set basic application	See section	Sequences
1-stage compressor for heating or cooling	2-pipe	3.6.2	H (\) C (/)
1-stage compressor and electric heater (for cooling only: disable electric heater via P13)	2-pipe and electric heater	3.6.3	El H + H (A \) El H + C (A /) C (/)
1-stage compressor for heating and cooling	4-pipe	3.6.4	H + C (\ /)

- Notes:
- Minimum ON/OFF time: P48 / P49
 - Fan operation: P52 (0 = disabled, 1 = enabled)
 - Fan speed: P53 (1 = 1-speed, 2 = 3-speed)

4-pipe applications

On 4-pipe applications, the Comfort setpoint (w) is in the middle of the dead zone, between the heating and cooling sequence.

The dead zone can be adjusted via parameter P33.

If manual changeover is selected, then either the cooling sequence or the heating sequence is released. In this case, the Comfort setpoint is at the selected heating or cooling sequence.

Application	Comfort mode			Economy / Protection mode
	Heating and cooling	Heating only ¹⁾	Cooling only ¹⁾	Heating and/or cooling
4-pipe				

1) Manual changeover, P01 = 2

W = setpoint in Comfort mode

$W_{\text{Heat/Eco/Prot}}$ = heating setpoint for Economy or Protection mode

$W_{\text{Cool/Eco/Prot}}$ = cooling setpoint for Economy or Protection mode

3.7 Control outputs

3.7.1 Overview

Overview of control outputs

Different control output signals are available. They need to be defined during commissioning (see below).

Control output → Product no. ↓	2-position	3-position
RDF302, RDF302/VB, RDF302.B	Y11, Y21 (2 x SPST)	Y11, Y21 *) (1 x ▲ / ▼)

*) Only on 2-pipe application

ON/OFF control signal (2-position)

The valve or compressor receives the **OPEN/ON** command via control output Y11 or Y21 when...

1. the acquired room temperature is below the setpoint (heating mode) or above the setpoint (cooling mode).
2. the control outputs have been inactive for more than the "Minimum output OFF-time" (factory setting 1 minute, adjustable via parameter P48).

OFF command when...

1. the acquired room temperature is above the setpoint (heating mode) or below the setpoint (cooling mode).
2. the valve has been active for more than the "Minimum output on-time" (factory setting 1 minute, adjustable via parameter P49).

Electric heater control signal (2-position)

The electric heater receives an **ON** command via the auxiliary heating control output (Y..., see Mounting Instructions) when...

1. the acquired room temperature is below the "Setpoint for electric heater"
2. the electric heater has been switched off for at least 1 minute

The **OFF** command for the electric heater is output when...

1. the acquired room temperature is above the setpoint (electric heater)
2. the electric heater has been switched on for at least 1 minute

Caution

A safety limit thermostat (to prevent over-temperatures) must be provided externally.

Adaptive temperature compensation for electric heater

When an electric heater is connected directly to the ON/OFF Y21, the current causes the relay contact to heat up. This falsifies the reading of the internal temperature sensor. The thermostat compensates the temperature if the rated current/power of the electric heating is entered in the parameters P46 (load current electric heater): factory setting: 0 A, setting range: 0.0...5.0 A.

3-position control signal

Output Y11 provides the **OPEN** command, and Y21 the **CLOSE** command to the 3-position actuator.

The factory setting for the actuator's running time is 150 seconds. It can be adjusted via parameter P44.

The parameter is only visible if 3-position is selected via DIP switches.

Synchronization

1. When the thermostat is powered up, a closing command for the actuator running time + 150% is provided to ensure that the actuator fully closes and synchronizes to the control algorithm.
2. When the thermostat calculates the positions "fully close" or "fully open", the actuator's running time is extended + 150% to ensure the right actuator position is synchronized to the control algorithm.
3. After the actuator reaches the position calculated by the thermostat, a waiting time of 30 seconds is applied to stabilize the outputs.

3.7.2 Control outputs configuration (setting via DIP switches or Modbus commissioning tool)

For the control outputs of a 2-pipe application, either On/Off or 3-position can be set via DIP switches or via Modbus commissioning tool (see section 3.4). Other applications, e.g. 4-pipe and 2-pipe with electric heater, only have On/Off type of outputs.



Plant type

The application and control output can be changed between On/Off and 3-position via Modbus.

3.8 Fan control

The fan operates in automatic mode or at the selected speed with manual mode. In automatic mode, the fan speed depends on the setpoint and the current room temperature. When the room temperature reaches the setpoint, the control valve closes and the fan switches off or stays at fan speed 1 (parameter P60; factory setting: 0 = fan speed 1 in dead zone).

Only one fan output at a time is on, either Q1, Q2 or Q3.

The fan speed and mode can be changed via Modbus.

The fan speed and mode can be monitored via Modbus.



Fan command value



Fan operation

Fan output

3-speed fan control with modulating heating / cooling control

The individual switching points for **ON** of each fan stage can be adjusted via control parameters P55...P57. The fan speed switch off point is 20% below the switch on point. The diagrams below show fan speed control for modulating PI control.

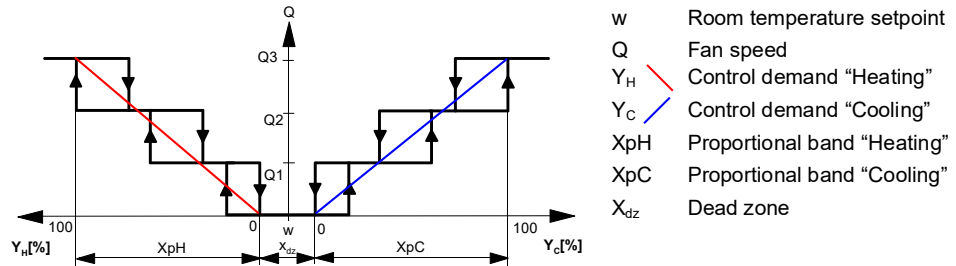

Note: The diagram only shows the PI thermostat's proportional part.

3-speed fan control with ON/OFF heating / cooling control

On applications with 2-position control:

- 1) The switching point for low fan speed (Q1) is synchronized to the heating / cooling output. Parameter "Switching point fan speed low" P57 is not relevant.
- 2) The maximum switching range of the fan (X_{pH_{Fan}} / X_{pC_{Fan}}) is defined by the switching differential (SDH/SDC) via a look-up table.

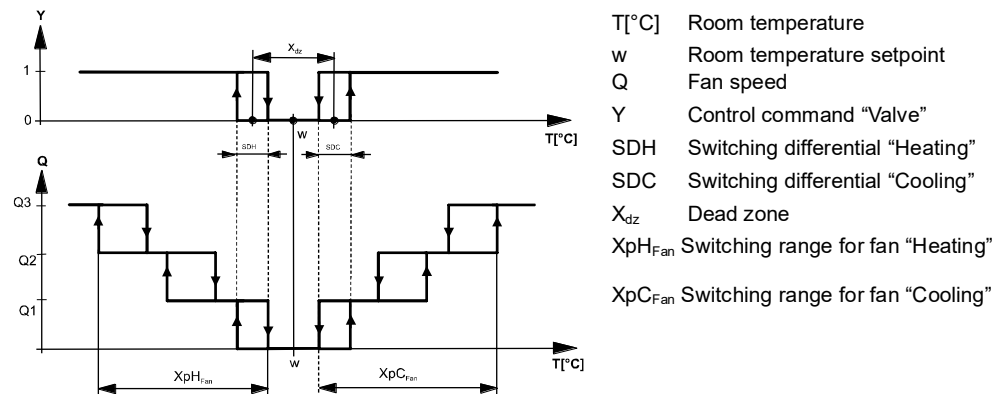

Look-up table with ON/OFF control

SDH/SDC [K]	0.5	1.0	1.5	2.0	2.5	3.0	3.5	4.0	>4.5
X _{pH_{Fan}} /X _{pC_{Fan}} [K]	2	3	4	5	6	7	8	9	10

1-speed / 3-speed fan

The thermostat can control a 1- or 3-speed fan (selected via control parameter P53). A 1-speed fan is connected to terminal Q1, a 3-speed fan to terminals Q1, Q2 and Q3.

Fan operation as per heating / cooling mode, or disabled

Fan operation can be limited to be active with cooling only or heating only, or even be totally disabled via control parameter "Fan control" P52.

When fan operation is disabled, the fan symbol on the display disappears and pressing the fan button has no impact.

This function allows you to use the thermostat on universal applications such as chilled / heated ceilings and radiator, etc. (see section 3.6.5).

Fan minimum on- time

In automatic mode, a dwelling time of 2 minutes (factory setting) is active. The fan maintains each speed for at least 2 minutes before it changes to the next speed. This minimum on-time can be adjusted from 1...6 minutes via parameter P59.

Fan operation in dead zone (fan kick)

In automatic fan mode and with the room temperature in the dead zone, the control valve is normally closed and the fan disabled. With the "Fan kick" function, the fan can be released from time to time at low speed for minimum on-time (see above) even if the valve is closed.

This function can be used to avoid damage from moisture due to a lack of air circulation, or to allow a return air temperature sensor to acquire the correct room temperature.

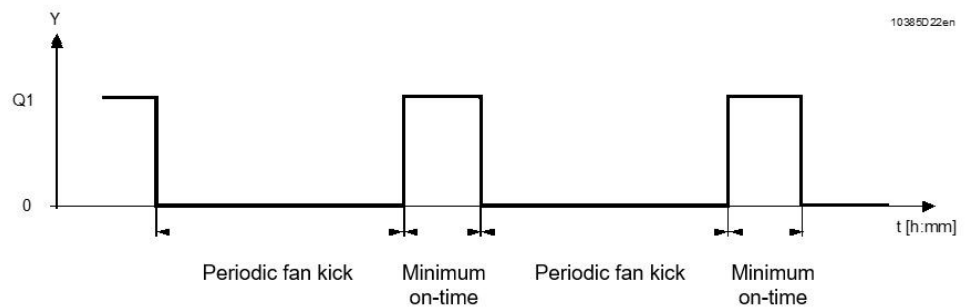

The periodic fan kick time can be selected individually for Comfort mode via parameter P60, and for Economy mode via parameter P61.

Note: Fan kick value "0" means the fan runs continuously in the dead zone.
Fan kick value "OFF" means the fan does not run in the dead zone.

Fan start

When the fan starts from standstill, it starts at speed 3 for 1 second to ensure safe fan motor start by overcoming inertia and friction (selected via parameter P58).

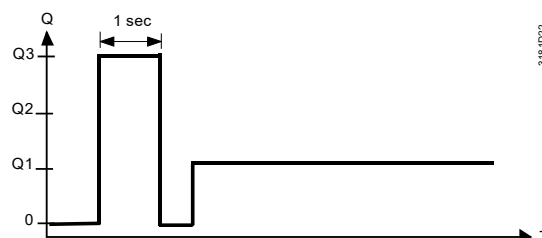

Fan overrun for electric heater

When the electric heater is switched off, the fan overruns for 60 seconds (parameter P54) to avoid over-temperature of the electric heater or prevent the thermal cutout from responding.



In case of fan failure, the thermostat cannot protect the electric heater against over-temperature. For this reason, the electric heater must feature a separate safety device (thermal cutout).

Clean fan filter reminder

The “Clean fan filter reminder” function counts the fan operating hours and displays message “FIL  “ to remind the user to change / clean the fan filter as soon as the threshold is reached. This does not impact the thermostat's operation, which continues to run normally. This function can be set via parameter P62 (Service Filter).

The “Clean fan filter reminder” is reset when the operating mode is manually set to Protection and back.



Fault information

The ‘Clean fan filter reminder’ and error information (see 3.11.1) can be obtained via Modbus object: Fault information

3.9 Multifunctional input, digital input

The thermostat has 2 multifunctional inputs X1 and X2. RDF302.B does not have inputs X1 and X2.

An NTC type sensor like the QAH11.1 (AI, analog input) or a switch (DI, digital input) can be connected to the input terminals. The functionality of the inputs can be configured via parameters P38 + P39 for X1 and P40 + P41 for X2.



X1 input
X2 input

The current temperature or state of the inputs X1/X2 is available on Modbus for monitoring purposes.

The parameters can be set to the following values:

#	Function of input	Description	Type X1/X2
0	Not used	No function.	--
1	External / return air temperature	Sensor input for external room temperature sensor or return air temperature sensor to acquire the current room temperature, or floor heating temperature sensor to limit the heating output. <i>Note:</i> The room temperature is acquired by the built-in sensor if the floor temperature limitation function is enabled via parameter P51.	AI



Heating / cooling
changeover

#	Function of input	Description	Type X1/X2
2	Heating / cooling changeover	Sensor input for “Automatic heating / cooling changeover” function. A switch can also be connected rather than a sensor (switch closed = cooling, see section 3.5). Heating / cooling changeover is also possible via Modbus. In this case, the function must not be assigned to any local input X1, X2. See also section 3.5. Diagnostic value 0 °C is displayed for closed contact / 100 °C for open contact, if a switch is connected.	AI / DI



Window state

#	Function of input	Description	Type X1/X2
3	Operating mode switchover	Digital input to switch over the operating mode to Economy. If the operating mode switchover contact is active, user operations are ineffective and "OFF" is displayed. Operating mode switchover is also possible via Modbus. In this case, the function must not be assigned to any local input X1, X2. See also section 3.2.	DI
4	Dew point monitor	Digital input for a dew point sensor to detect condensation. Cooling is stopped if condensation occurs.	DI



Enable electric heater

#	Function of input	Description	Type X1/X2
5	Enable electric heater	Digital input to enable / disable the electric heater via remote control. Enable electric heater is also possible via Modbus. In this case, the function must not be assigned to any local input X1, X2. See also section 3.6.	DI



Fault information

#	Function of input	Description	Type X1/X2
6	Fault	Digital input to signal an external fault (example: dirty air filter). If the input is active, "ALx" is displayed and a fault is sent on the Modbus. See also section 3.11.1. (Alarm x, with x = 1 for X1, x = 2 for X2). <i>Note:</i> Fault displays have no impact on the thermostat's operation. They merely represent a visual signal.	DI



X1 input, X2 input

#	Function of input	Description	Type X1/X2
7	Monitor input (Digital)	Digital input to monitor the state of an external switch via Modbus.	DI



X1 input, X2 input

#	Function of input	Description	Type X1/X2
8	Monitor input (Temperature)	Sensor input to monitor the state of an external sensor (e.g. QAH11.1) via Modbus.	AI

- Operational action can be changed between normally open (NO) and normally closed (NC) via parameter P39, P41

- Each input X1 or X2 must be configured with a different function (1...5).
Exception: 1 or 2 inputs can be configured as fault (6) or monitor input (7,8)
- X1 is factory-set to "Operating mode switchover" (3), X2 to "External sensor" (1)

If a multifunctional input is configured as analog: "Err" will be displayed when the output is out of range (0...49 °C), open or shorted.

For more detailed information, refer to section 3.4 "Applications".

Installation notes:

- For inputs X1 and X2, one physical switch can be used for up to 20 thermostats (parallel connection).
- For sensors on inputs X1, X2, or D1, the cable length is max. 80 m.

3.10 Handling faults

Temperature out of range

When the room temperature is outside the measuring range, i.e. above 49 °C or below 0 °C, the limiting temperatures blink, e.g. "0 °C" or "49 °C".

In addition, the heating output is activated if the current setpoint is not set to "OFF", the thermostat is in heating mode and the temperature is below 0 °C.

For all other cases, no output is activated.

The thermostat resumes Comfort mode after the temperature returns to within the measuring range.

For fault status messages on the Modbus, see section 3.11.1.



3.11 Modbus RTU mode

The RDF302, RDF302/VB and RDF302.B thermostats support communication protocol (Modbus RTU mode) as per the Modbus specification (refer to: <http://www.modbus.org>).

Device address	The device address range is from 1 to 247. The device address can be changed via parameter P81. (factory setting = 1)
Baud rate	The available baud rates are 4800 bps, 9600 bps, 19200bps and 38400 bps. The baud rate can be changed via parameter P68. (factory setting = 19200 bps)
Parity	The parity can be set to none (no parity), odd or even. The parity can be changed via parameter P70. (factory setting = even)

Note Any change, e.g. device address, baud rate and parity, will become effective only after turning the power supply off then on again.

3.11.1 Fault function on Modbus



Fault information

If a fault occurs (e.g. digital fault input, dew point, etc.) then a fault will be displayed on the thermostat and the fault information can be read via Modbus.

Priority of alarms

If more than one alarms occur at the same time, the alarm with the highest priority will be available via Modbus while the thermostat will display all active alarms alternatively.

The table below shows the error code and default alarm texts.

Priority	Fault	Thermostat	Fault information on Modbus
		Display	Default fault text
-	No fault	---	No fault
1	Condensation	🔔💧	Condensation in the room
2	External fault input X1 ¹⁾	🔔AL1	Fault input 1
3	External fault input X2 ¹⁾	🔔AL2	Fault input 2
4	Clean filter reminder	🔔FIL	Dirty filter

¹⁾ RDF302.B does not have inputs X1 and X2.

Default alarm texts are stored in the thermostat's non-volatile memory and can be adjusted using the Modbus commissioning tool.

3.12 Communication objects

3.12.1 Overview

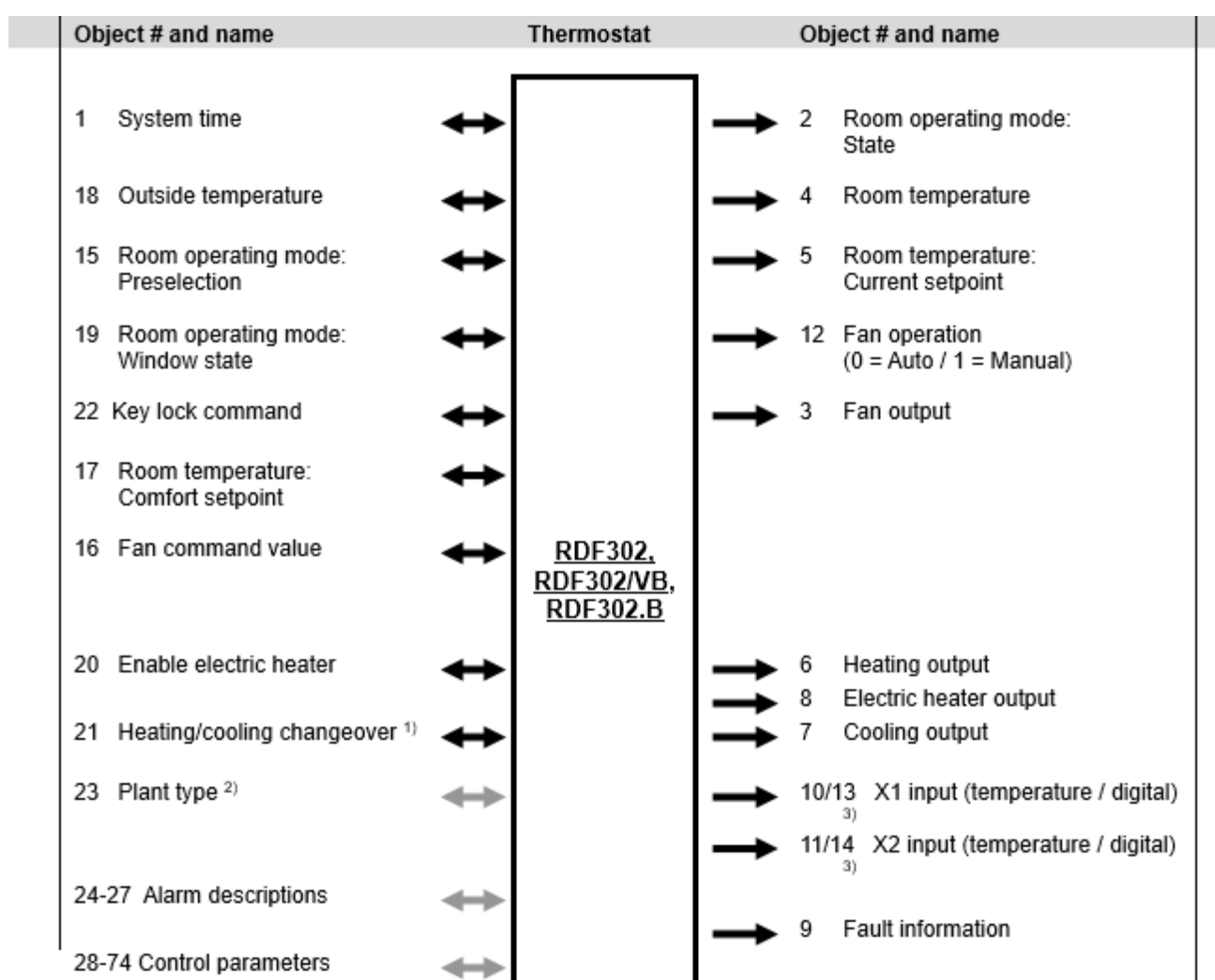

→ Output communication object

↔ Input & output communication object

↔ Configuration & commissioning communication object

1) P01 must be set to 3, the manual heating/cooling changeover
Either using local input, X1/X2 input, or Modbus command

2) Dip switch position 1 to 3 must be set to OFF-OFF-OFF

3) Not applicable to RDF302.B

Object No.	Object	Address (Decimal)	Register Length	Read Only (RO) or Read/Write (R/W)	Functioncode(HEX)		MultiBytes Access Group	Special Process	Default	Data Type (Decimal)	
					0x03---Read Holding Registers	0x04---Read Input Registers					
										100 = High Fan	
17	Room Temperature: Comfort setpoint	0103	1	R/W	0x03	0x06	2	x50		5 ... 40 °C	
18	Outside temperature	0104	1	R/W	0x03	0x06	2	x50		0 ... 49 °C	
19	Room operating mode: Window state	0105	1	R/W	0x03	0x06	2	-	Close	0 = Close (default) 1 = Open	
20	Enable electric heater	0106	1	R/W	0x03	0x06	2	-	Enable	0 = Disable 1 = Enable	
21	Heating/cooling changeover	0107	1	R/W	0x03	0x06	2	-	heating	0 = cooling, 1 = heating	
22	Button lock command	0108	1	R/W	0x03	0x06	2	-	Unlock	4 = Lock all buttons 3 = Lock operating button only 2 = Lock fan button only 1 = Lock buttons (+ & -) only. 0 = Unlock	
23	Application	Plant type	0109	1	R/W	0x03	0x06	2	-	NONE	0=NONE 1=2P 2=2P3P 3=2PEL 4=4P
24	Alarm descriptions	Fault text 1	0200... 0209	10	R/W	0x03	0x10		-	Condensation in room	len <= 20
25		Fault text 2	0300... 0309	10	R/W	0x03	0x10		-	Fault input 1	len <= 20
26		Fault text 3	0400... 0409	10	R/W	0x03	0x10		-	Fault input 2	len <= 20
27		Fault text 4	0500... 0509	10	R/W	0x03	0x10		-	Filter dirty	len <= 20
28	Parameter table	P01	0001	1	R/W	0x03	0x06	-	-	When 2-pipe 1:= Cooling only 2:= H/C changeover manual When 4-pipe 4:= Automatic	0:= Heating only 1:= Cooling only 2:= H/C changeover manual 3:= H/C changeover auto 4:= Heating and Cooling
29		P02	0002	1	R/W	0x03	0x06	-	-	1	Communication unit / time prog unit: 1:= Comf - Protection 2:= Comf - Eco - Prot
30		P04	0004	1	R/W	0x03	0x06	3	-	°C (0)	°C := Degrees Celsius °F := Degrees Fahrenheit
31		P05	0005	1	R/W	0x03	0x06	3	x50	0 K	- 3 ... 3 K

Object No.	Object	Address (Decimal)	Register Length	Read Only (RO) or Read/Write (R/W)	Functioncode(HEX)		MultiBytes Access Group	Special Process	Default	Data Type (Decimal)	
					0x03---Read Holding Registers	0x04---Read Input Registers					
32	Parameter table	P06	0006	1	R/W	0x03	0x06	3	-	0	0:= Room Temperature 1:= Setpoint 2 = BUS temperature
33		P07	0007	1	R/W	0x03	0x06	3	-	0	0:= --- (No display) 1:= °C and °F 2:= Outside temperature [via bus] 3:= Time of day (12h) [via bus] 4:= Time of day (24h) [via bus]
34		P08	0008	1	R/W	0x03	0x06	3	x50	21 °C	5 ... 40 °C
35		P09	0009	1	R/W	0x03	0x06	3	x50	5 °C	5 ... 40 °C
36		P10	0010	1	R/W	0x03	0x06	3	x50	35 °C	5 ... 40 °C
37		P11	0011	1	R/W	0x03	0x06	3	x50	15 °C	OFF(=4.5), 5 ~WcoolEco; WcoolEco=40 °C max
38		P12	0012	1	R/W	0x03	0x06	3	x50	30 °C	WHeatEco ... 40 °C,OFF(=40.5); WHeatEco=5C min
39		P13	0013	1	R/W	0x03	0x06	3	-	ON	1=ON: Enabled 0=OFF: Disabled
40		P14	0014	1	R/W	0x03	0x06	3	-	0	0= Unlocked 1= Auto locked 2= Manual locked
41		P30	0030	1	R/W	0x03	0x06	4	x50	2 K	0.5 ... 6 K
42		P31	0031	1	R/W	0x03	0x06	4	x50	1 K	0.5 ... 6 K
43		P33	0033	1	R/W	0x03	0x06	4	x50	2 K	0.5 ... 5 K
44		P34	0034	1	R/W	0x03	0x06	4	x50	2 K	0.5 ... 5 K
45		P35	0035	1	R/W	0x03	0x06	4	-	5 min	0...10 min
46		P36	0036	1	R/W	0x03	0x06	4	x50	16 °C	10...25 °C
47		P37	0037	1	R/W	0x03	0x06	4	x50	28 °C	27...40 °C
48		P38/P40 **	0038	1	R/W	0x03	0x06	-	-	X1 = 3, X2 = 1	X1(1byte HIGH), X2(1byte LOW) 0:= --- (no function) 1:= Room temp ext / Return temp (AI) 2:= H/C changeover (AI/DI) 3:= Operating mode contact [DI] 4:= Dew point sen. (DI) 5:= Enable electro heater (DI) 6:= Fault input (DI) 7:= Monitor input [Digital] 8:= Monitor input [Temp]
49		P39	0040	1	R/W	0x03	0x06	4	-	0 (N.O.)	0:= Normally open / Open 1:= Normally closed / Close
50		P41	0041	1	R/W	0x03	0x06	4	-	0 (N.O.)	0:= Normally open / Open 1:= Normally closed / Close
51		P44	0044	1	R/W	0x03	0x06	-	-	150 s	20...300 sec
52	P46	0182	1	R/W	0x03	0x06	-	x10	0	0.0~5.0	

Object No.	Object	Address (Decimal)	Register Length	Read Only (RO) or Read/Write (R/W)	Functioncode(HEX)		MultiBytes Access Group	Special Process	Default	Data Type (Decimal)	
					0x03---Read Holding Registers	0x04---Read Input Registers					
53	Parameter table	P48	0048	1	R/W	0x03	0x06	6	-	1 min.	1...20 minutes
54		P49	0049	1	R/W	0x03	0x06	6	-	1 min.	1...20 minutes
55		P50	0050	1	R/W	0x03	0x06	6	-	OFF	0 = OFF: Not active 1...5 min: Active with selected duration
56		P51	0051	1	R/W	0x03	0x06	6	x50	OFF	9=OFF, 10..50 °C
57		P52	0052	1	R/W	0x03	0x06	6	-	1	0:= Disabled 1:= Enabled 2:= Heating only 3:= Cooling only
58		P53	0053	1	R/W	0x03	0x06	6	-	3-speed	1:= 1-speed 2:= 3-speed
59		P54	0054	1	R/W	0x03	0x06	6	-	60 sec	0 ... 360 sec
60		P55	0055	1	R/W	0x03	0x06	6	-	100%	80..100%
61		P56	0056	1	R/W	0x03	0x06	6	-	65%	30..75%
62		P57	0057	1	R/W	0x03	0x06	6	-	10%	1..15%
63		P58	0058	1	R/W	0x03	0x06	6	-	ON	1 = ON: enabled 0 = OFF: disabled
64		P59	0059	1	R/W	0x03	0x06	6	-	2 min	1 ... 6 min
65		P60	0060	1	R/W	0x03	0x06	6	-	0	0...89min, OFF(90)
66		P61	0061	1	R/W	0x03	0x06	6	-	OFF	0...359min, OFF(360)
67		P62	0062	1	R/W	0x03	0x06	6	-	Off (0)	0 = Off, 100 ... 9900 hours
68		P65	0065	1	R/W	0x03	0x06	-	x50	8 °C	OFF(=4.5), 5 ~WcoolEco; WcoolEco=40 °C max
69		P66	0066	1	R/W	0x03	0x06	-	x50	OFF	WHeatEco ... 40 °C,OFF(=40.5); WHeatEco=5C min
70	P68	0068	1	R/W	0x03	0x06	8	-	2 = 19200bps	0 = 4800bps, 1 = 9600bps, 2 = 19200bps, 3 = 38400bps	
71	P69	0069	1	R/W	0x03	0x06	8	-	OFF	0 = OFF := Disabled 1 = ON := Enable	
72	P70	0070	1	R/W	0x03	0x06	8	-	Even	0 = Odd 1 = Even 2 = No parity	
73	P71	0071	1	R/W	0x03	0x06	8	-	OFF	0 = OFF := Disable 1 = ON := Reload start	
74	P81	0081	1	R/W	0x03	0x06	-	-	1	1...247	

* If a bus command is received via MODBUS for either COMFORT or ECONOMY operating mode, the symbol of the selected operating mode will be displayed.
i.e. either COMFORT or ECONOMY symbol only

If a bus command is received for PROTECTION mode, the AUTO TIMER symbol (Auto) will be displayed and all key buttons will be de-activated.

i.e. both PROTECTION and AUTO TIMER symbols

** RDF302.B does not have inputs X1 and X2. Parameters related x1 and X2 input functions are not applicable to RDF302.B.

System clock format

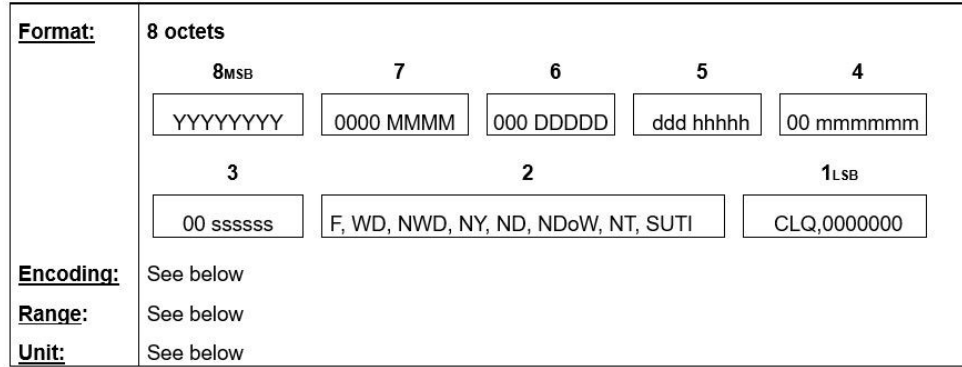

Datapoint Type

ID:	Name:		Encoding:	Range:	Unit:	Usage:
19.001	DPT_DateTime	Y	Binary, offset 1900 0 = 1900 255 = 2155	[0...255]	Year	General
		M	Binary 1 = January 12 = December	[1...12]	Month	
		D	Binary 1 = 1st day 31 = 31st day	[1...31]	Day of month	
		ddd	1 = Monday ... 7 = Sunday 0 = any day	[0...7]	Day of week	
		hhhhh	Binary	[0...24]	Hour of day	
		mmmmm	Binary	[0...59]	Minutes	
		sssss	Binary	[0...59]	Seconds	
		F	0 : Normal (No fault) 1 : Fault	{0,1}	Fault	
		WD	0 : Bank day (No working day) 1 : Working day	{0,1}	Working Day	
		NWD	0 : WD field valid 1 : WD field not valid	{0,1}	No WD	
		NY	0 : Year field valid 1 : Year field not valid	{0,1}	No Year	
		ND	0 : Month and Day of Month fields valid 1 : Month and Day of Month fields not valid	{0,1}	No Date	
		NDoW	0 : Day of week field valid 1 : Day of week field not valid	{0,1}	No Day of Week	
		NT	0 : Hour of day, Minutes and Seconds fields valid 1 : Hour of day, Minutes and Seconds fields not valid	{0,1}	No Time	
		SUTI	0 : Time = UT+X 1 : Time = UT+X+1	{0,1}	Standard Summer Time	
CLQ	0 : clock without ext. sync signal 1 : clock with ext. sync signal	{0,1}	Quality of Clock			

3.13 Control parameters

A number of control parameters can be readjusted to optimize control performance. This can be done on the thermostat via HMI or via commissioning / operating tool. These parameters can also be set during operation without opening the unit. In the event of a power failure, all control parameter settings are retained.

The control parameters are assigned to 2 levels:

- “Service level”, and
- “Expert level” including communications, diagnostics and test

The “Service level” contains a small set of parameters to set up the thermostat for the HVAC system and to adjust the user interface. These parameters can be adjusted any time.

Change parameters at the “Expert level” carefully, as they impact the thermostat’s control performance and functionality.

3.13.1 Parameter setting via local HMI

Enter only “Service” level

1. Press buttons + and – simultaneously for 3 seconds. Release and press button + again for 3 seconds within 2 seconds. The display shows “P01”. Continue with step 2.

Enter “Service” and “Expert” level.

1. Press buttons + and – simultaneously for 3 seconds. Release and press button – again for 3 seconds within 2 seconds. The display shows “P01” and service.

Adjust parameters

2. Repeatedly press the + or – button to select the required parameter.

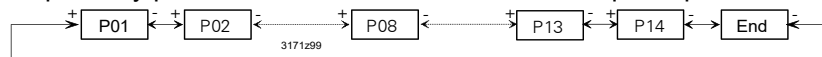

3. Press + and – simultaneously. The current value of the selected parameter begins to flash, allowing you to change the value by repeatedly pressing + or –.
4. The next parameter is displayed when you press + and – again simultaneously.
5. Repeat steps 2 to 4 to display and change additional parameters.
6. Press + or – until “End” is displayed, and then press + and – simultaneously to save the change and exit parameter entry mode.

Reset parameters

The factory setting for the control parameters can be reloaded via parameter P71, by changing the value to “ON”, and confirming by pressing buttons + and – simultaneously. The display shows “8888” during reload.

3.13.2 Parameter setting / download via Modbus communication tool

Control parameters can be adjusted via Modbus either by local HMI or Modbus commissioning tools.

Please refer to section 4.2 for commissioning.

3.13.3 Parameters of the “Service level”

Parameter	Name	Factory setting	Range
	Service level		
P01	Control sequence	2-pipe: [0...3] 1 (Cooling only) 4-pipe: [2...4] 4 (Heating & Cooling)	0 = Heating only 1 = Cooling only 2 = Manual Heating or Cooling 3 = Auto Changeover 4 = Heating & cooling
P02	Mode selection by user via operating mode button	1 (Comfort, Protection)	1 = Comfort, Protection 2 = Comfort, Economy, Protection
P04	Selection of °C or °F	°C	0 = °C 1 = °F
P05	Sensor calibration (build in sensor only)	0.0 °C	-3...3 °C
P06	Standard temperature display	0 (Room temperature)	0 = Room temperature 1 = Setpoint 2 = BUS temperature
P07	Additional user information	0 (No display)	0 = No display 1 = Temperature in °C/°F 2 = Outside temperature (0...49 °C) (via Modbus) 3 = Time of day (12 h, via Modbus) 4 = Time of day (24 h, via Modbus)
P08	Comfort basic setpoint	21 °C	5...40 °C
P09	Minimum setpoint limitation in Comfort ($W_{min_{Comf}}$)	5 °C	5...40 °C
P10	Maximum setpoint limitation in Comfort ($W_{max_{Comf}}$)	35 °C	5...40 °C
P11	Setpoint of heating in Economy ($W_{heat_{Eco}}$)	15 °C	OFF, 5 °C... $W_{cool_{Eco}}$
P12	Setpoint of cooling in Economy ($W_{cool_{Eco}}$)	30 °C	OFF, $W_{heat_{Eco}}$...40 °C
P13 *	Electrical heater in cooling mode	ON	OFF = disabled ON = enabled
P14	Key lock (Press operating mode button  for 5 seconds to lock or unlock the buttons)	0 (Disabled)	0 = Disabled 1 = Auto lock 2 = Manual lock





Note: *) Parameter P13 is only displayed for application "2-pipe with electric heater".
All temperature settings are in increments of 0.5 °C.

3.13.4 Parameters of the "Expert level with diagnostics and test"

Parameter	Name	Factory setting	Range
	Expert level		
P30	P-band/Switching differential for heating mode	2 K	0.5 ... 6 K
P31	P-band/Switching differential for cooling mode	1 K	0.5 ... 6 K
P33	Dead zone in Comfort mode	2 K	0.5 ... 5 K
P34	Setpoint differential	2 K	0.5 ... 5 K
P35**	Integral time	5 min	0...10 min
P36**	Heating/cooling changeover switching point for cooling	16 °C	10...25 °C
P37**	Heating/cooling changeover switching point for heating	28 °C	27...40 °C
P38****	Input X1	3 = Op mode c/o	0 = --- (no function) 1 = Room temp ext. sensor / Return air temp (AI) 2 = H/C changeover (AI/DI) 3 = Operating mode contact (DI) 4 = Dew point sensor (DI) 5 = Enable electric heater (DI) 6 = Fault input (DI) 7 = Monitor input (Digital) 8 = Monitor input (Temp)
P39****	Operating action for X1 if digital input	NO	NO = Normally Open NC = Normally Close
P40****	Input X2	1 = Ext. sensor	0 = --- (no function) 1 = Room temp ext. sensor / Return temp (AI) 2 = H/C changeover (AI/DI) 3 = Operating mode contact (DI) 4 = Dew point sensor (DI) 5 = Enable electric heater (DI) 6 = Fault input (DI) 7 = Monitor input (Digital) 8 = Monitor input (Temp)
P41****	Operating action for X2 if digital input	0 (N.O.)	0 = Normally Open 1 = Normally Close
P44***	Actuator running time Y11/Y21	150 s	20...300 sec
P46	Y2x load current	0.0 A	0.0 to 5.0 A
P48	On time minimum for 2-pos output control	1 min.	1...20 min
P49	Off time minimum for 2-pos output control	1 min.	1...20 min
P50	Purge time	OFF	OFF: Not active 1...5 min: Active with selected duration
P51	Flow temp limit floor heating	OFF	OFF, 10...50 °C
P52	Fan control	1	0 = Disabled 1 = Enabled 2 = Heating only 3 = Cooling only
P53	Fan speeds	2	1 = 1-speed 2 = 3-speed
P54*	Fan overrun time	60 sec	0...360 sec
P55	Fan speed switching point high	100%	80...100%
P56	Fan speed switching point med	65%	30...75%
P57	Fan speed switching point low	10%	1...15%
P58	Fan start kick	ON	ON: Enabled OFF: Disabled
P59	Fan minimum on time	2 min	1...6 min
P60	Periodic fan kick Comfort	0	0...89 min, OFF(90)
P61	Periodic fan kick Eco	OFF	0...359 min, OFF(360)

Parameter	Name	Factory setting	Range
	Expert level		
P62	Service filter	Off (0)	Off, 100...9900 hrs
P65	Protection heating setpoint	8 °C	OFF, 5...WCoolProt; WCoolProt = 40 °C max
P66	Protection cooling setpoint	OFF	OFF, WHeatProt... 40; WHeatProt = 5°C min
P68	Baud Rate	2	0 = 4800 BPS 1 = 9600 BPS 2 = 19200 BPS 3 = 38400 BPS
P69	Temporary Comfort setpoint	OFF	OFF = Disabled ON = Enabled
P70	Parity	1	0 = Odd 1 = Even 2 = No parity
P71	Restore factory setting	OFF	OFF = Disabled ON = Reload start "8888" is displayed for 3s during reload process
P81	Device address	1	1 ... 247

- Note: *) Parameter P54 is only displayed for application "2-pipe with electric heater". All temperature settings are in increments of 0.5 °C.
 **) Parameters P36-37 and P50 will only appear when either X1 or X2 set to 2, the H/C changeover.
 ***) Parameters P35 and P44 will only appear when the application (DIP switch) set to 2 pipe 3 position.
 ****) Parameters related to X1 and X2 input functions are not applicable to RDF302.B.

Parameter	Name	Range
	Diagnostics & test	
d01	Application number	NONE = (No application) 2P = 2-pipe 2P3P = 2-pipe 3-position 2PEH = 2-pipe with electric heater 4P = 4-pipe
d02	X1 state	0 = Not activated (for DI) 1 = Activated (DI) 0...49 °C = Current temp. value (for AI) 00  = H/C Input shorted 100  = H/C Input open
d03	X2 state	0 = Not activated (for DI) 1 = Activated (DI) 0...49 °C = Current temp. value (for AI) 00  = H/C Input shorted 100  = H/C Input open
d05***	Test mode for checking the Y11/Y21 This parameter can only be quit when the setting is back at "----". Press buttons + and – simultaneously to escape. actuator's running direction	"----" = no signal on outputs Y11 and Y21 OPE = output Y11 forced opening CLO = output Y21 forced closing

- Note: ***) Parameters d05 will only appear when the application (DIP switch) set to 2 pipe 3 position.

4. Handling

4.1 Mounting and installation

Mount the room thermostat on a recessed square conduit box with 60.3 mm fixing centers. Do not mount on a wall in niches or bookshelves, behind curtains, above or near heat sources, or exposed to direct solar radiation. Mount about 1.5 m above the floor.

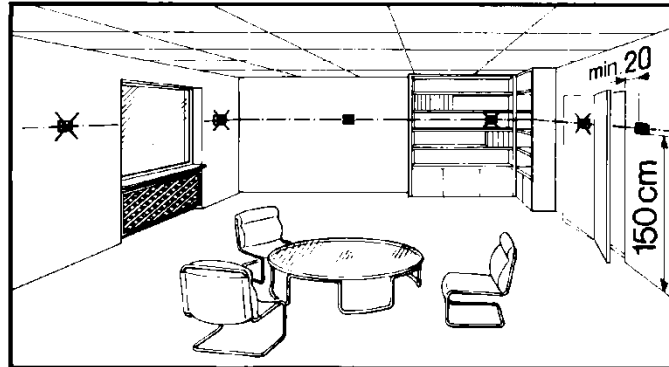

Mounting



- Mount the room thermostat in a clean, dry indoor place without direct airflow from a heating / cooling device, and not exposed to dripping or splash water
- In case of limited space in the conduit box, use mounting bracket ARG70.3 to increase the headroom by 10 mm

Wiring



See Mounting Instructions M3079 enclosed with the thermostat.

- Comply with local regulations to wire, protection and earth the thermostat.
- The device has no internal fuse for supply lines to fan and actuators. To avoid risk of fire and injury due to short-circuits, the AC 230 V mains supply line must have a circuit breaker with a rated current of no more than 10 A.
- Properly size the cables to the thermostat, fan and valve actuators for AC 230 V mains voltage.
- Use only valve actuators rated for AC 230 V
- The wiring cross section used for power supply (L, N), fan/relays (Qxx) and 230 V outputs (Yxx -N) must be adapted to the preceding overload protection elements (max 10A) under all circumstances. Comply under all circumstances with local regulations.
- Cables of SELV inputs X1-M / X2-M: Use cables with min AC 230 V insulation, as the conduit box carries AC 230 V mains voltage.
- Inputs X1-M or X2-M: Several switches (e.g. summer / winter switch) may be connected in parallel. Consider overall maximum contact sensing current for switch rating.
- Isolate the cables of Modbus communication input +, - and REF for 230 V.
- No metal conduits.
- No cables provided with a metal shield.
- Disconnect from supply before opening the cover.

4.2 Commissioning

Applications

The room thermostats are delivered with a fixed set of applications.

Select and activate the relevant application during commissioning using one of the following tools:

- Local DIP switch and HMI
- commissioning tools for RS485 Modbus RTU

DIP switches

Set the DIP switches before snapping the front panel to the mounting plate, if you want to select an application via **DIP switches**.

All DIP switches need to be set to “OFF” (remote configuration), if you want to select an application via Modbus commissioning tool.

After power is applied, the thermostat starts with all LCD segments flashing for about 3 seconds. Then, the thermostat will be at normal display mode and is ready for commissioning by qualified HVAC staff.

If all DIP switches are OFF, the display reads "NONE" to indicate that application commissioning via a tool is required.

Note: Each time after a different application is selected, the thermostat reloads the factory settings for all control parameters EXCEPT the parameters for communication settings. e.g. device addresses (P81), Baud rate (P68) and Parity (P70)

Control parameters

The thermostat's control parameters can be set to ensure optimum performance of the entire system. The parameters can be adjusted using

- Local HMI
- commissioning tools

The control parameters of the thermostat can be set to ensure optimum performance of the entire system (see section 3.13, control parameters).

Control sequence

- The control sequence may need to be set via parameter P01 depending on the application. The factory setting is as follows:

Application	Factory setting P01
2-pipe and chilled / heated ceiling	1 = cooling only
4-pipe, chilled ceiling and radiator	4 = heating and cooling

Compressor-based applications



- When the thermostat is used with a compressor, adjust the minimum output on-time (parameter P48) and OFF-time (parameter P49) for Y11/Y21 to avoid damaging the compressor or shortening its life due to frequent switching

Calibrate sensor

- Recalibrate the temperature sensor if the room temperature displayed on the thermostat does not match the room temperature measured (after min. 1 hour of operation). To do this, change parameter P05

Setpoint and range limitation

- We recommend to review the setpoints and setpoint ranges (parameters P08...P12) and change them as needed to achieve maximum comfort and save energy

4.3 Operation

See also Operating Instructions B3171 [2] enclosed with the thermostat.

Layout

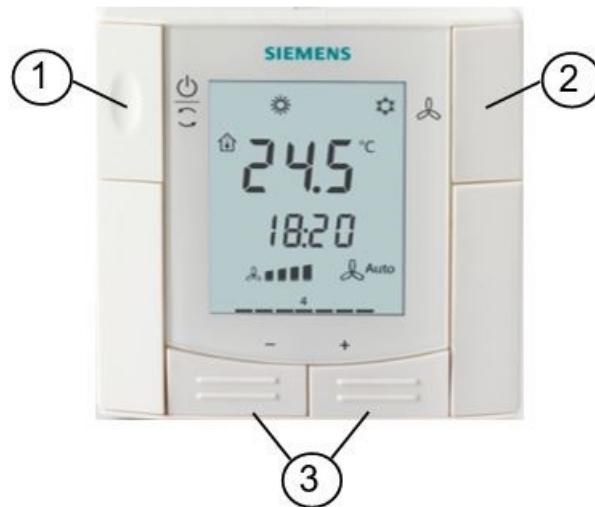

RDF302, RDF302/VB, RDF302.B

- 1 Operating mode selector
- 2 Button to change fan operation
- 3 Buttons to adjust setpoints and control parameters

Button operation

User action	Effect, description
Normal operation	Actual operating mode and state are indicated by symbols
Press any button (thermostat in normal operation)	Backlit LCD turns on and... (see below for further action) After the last operation and a timeout of 20 seconds, the LCD backlight turns off
Press left button	Change operating mode
Press left button (P01 = 2)	Toggle between heating and cooling
Press left button >5 seconds	Activate / deactivate key lock
Press right button	Change fan mode
Press + or –	Adjusts the Comfort room temperature setpoint . Thermostat changes to Comfort mode
Press + and – >3 seconds, release, then press + again >3 seconds	Go to parameter setting mode “Service level”
Press + and – >3 seconds, release, then press – again >3 seconds	Go to parameter setting mode “Expert level”, diagnostics and test

Display

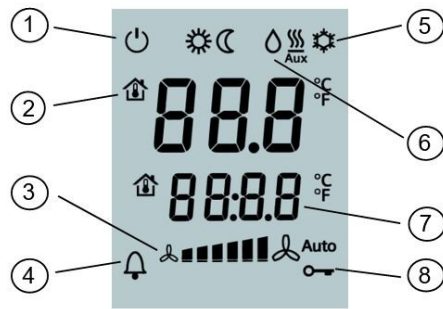

- | | |
|--|--|
| <p>1 Operating mode</p> <ul style="list-style-type: none"> ☰ Protection ☀ Comfort ☾ Economy | <p>5 Heating/cooling mode</p> <ul style="list-style-type: none"> ☀ Cooling ☀ Heating ☀ Aux Electrical heater active |
| <p>2 Displays room temperature, setpoints and control parameters</p> <ul style="list-style-type: none"> 🏠 Symbol indicates current room temperature | <p>6 🌧 Condensation in room (dew point sensor active)</p> |
| <p>3 Fan mode</p> <ul style="list-style-type: none"> 🌀 Auto Auto fan active 🌀 Fan speed low, medium, high | <p>7 Additional user information, like outdoor temperature (🏠) or time from Modbus (selectable via parameters)</p> |
| <p>4 🔔 Indicates fault or reminder</p> | <p>8 🔑 Key lock active</p> |

4.4 Disposal



The device is considered electrical and electronic equipment for disposal in terms of the applicable European Directive and may not be disposed of as domestic garbage.

- Dispose of the device through channels provided for this purpose.
- Comply with all local and currently applicable laws and regulations.

5. Connection

5.1 Connection terminals

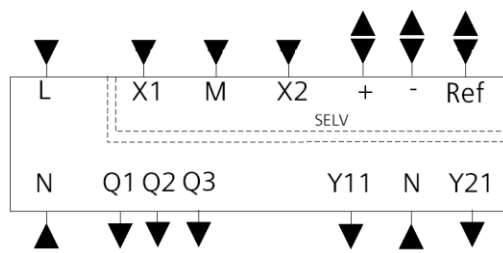

L, N	Operating voltage AC 230 V
Q1	Control output "Fan speed 1 AC 230 V"
Q2	Control output "Fan speed 2 AC 230 V"
Q3	Control output "Fan speed 3 AC 230 V"
Y11, Y21	Control output "Valve" AC 230 V (N.O., for normally closed valves), output for compressor or output for electrical heater
X1, X2 ¹⁾	Multifunctional input for temperature sensor (e.g. QAH11.1) or potential-free switch Factory setting: X1 = Operating mode switchover contact X2 = External sensor (function can be selected via parameter P38/P40).
M ¹⁾	Measuring neutral for sensor and switch
+	RS485 Modbus connection
-	RS485 Modbus connection
REF	RS485 signal/common ground (Differential common)

¹⁾ RDF302.B does not have inputs X1, X2 and M.

5.2 Connection diagrams

Application

2-pipe / heating or cooling – ON/OFF

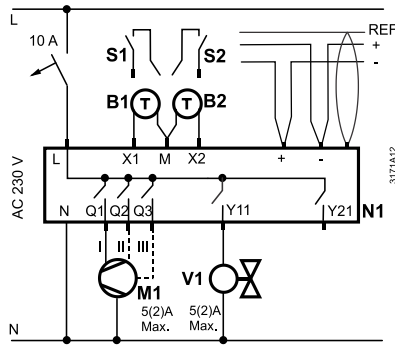

- N1 Room thermostat RDF302...
- M1 1- or 3-speed fan
- V1 Valve actuator, 2- or 3-position
- V1, V2 Valve actuator, 2-position
- E1 Electric heater
- C1, C2 1-stage compressor
- S1, S2 Switch (keycard, window contact, presence detector, etc.)
- B1, B2 Temperature sensor (return air temperature, external room temperature, changeover sensor, etc.)
- + RS485 Modbus connection
- RS485 Modbus connection
- REF RS485 signal/common ground (Differential common)

RDF302.B does not have inputs X1, X2 and M.

2-pipe, / heating or cooling – 3-position
Y11 = Open
Y21 = Close

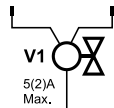

2-pipe and el. heater/
Heating or cooling and el. Heater

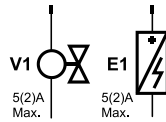

4-pipe /
Heating and radiator
V1 = Heating
V2 = Cooling

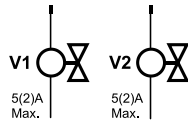

1-stage compressor
C1 = Heating
and / or
C2 = Cooling

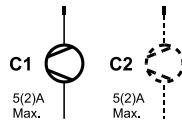

1-stage compressor
and electric heater

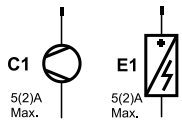

6. Mechanical design

6.1 General

The thermostats consist of 2 parts:

- Front panel with electronics, operating elements and built-in room temperature sensor.
- Mounting base with power electronics.

The rear of the mounting base contains the screw terminals.

The base fits on a square conduit box with 60.3 mm fixing centers.

Slide the front panel in the mounting base and snap on.

Operation and settings

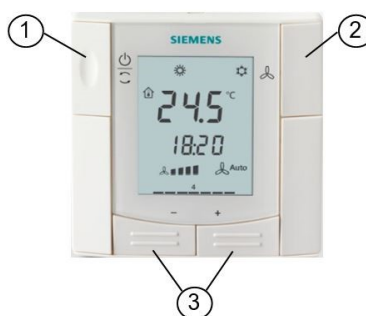

RDF302, RDF302/VB, RDF302.B

1. Operating mode selector
2. Change fan operation
3. Adjust setpoints and control parameters



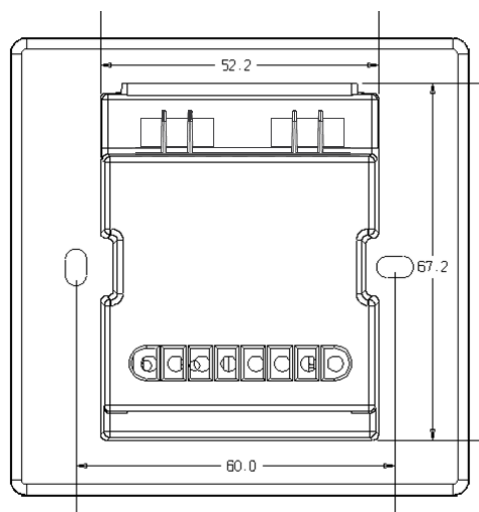
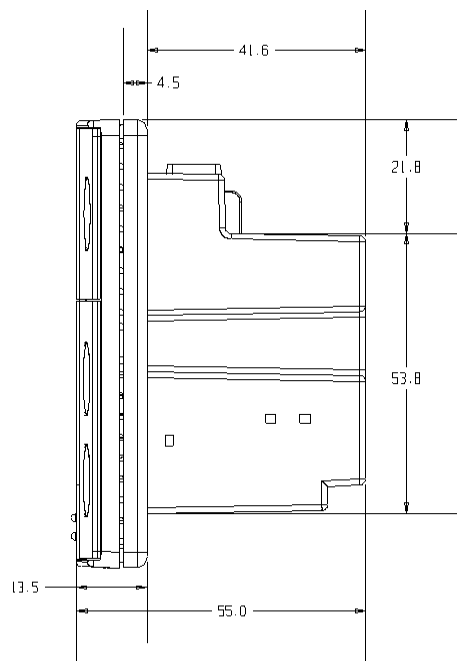
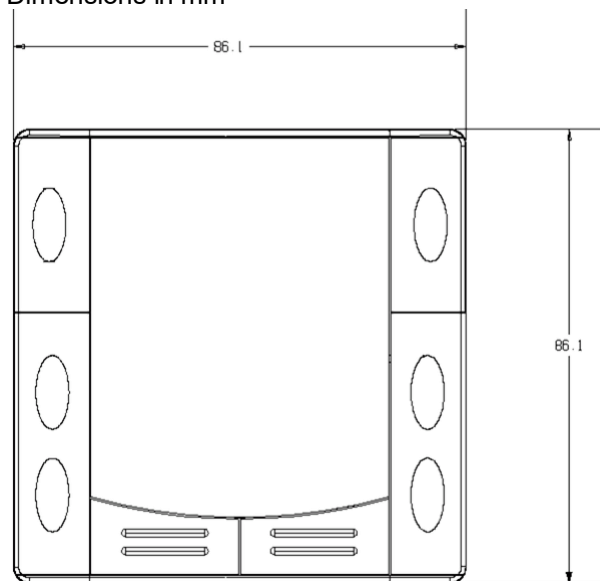

For operation, refer to section 4.3.

6.2 Dimensions

Dimensions in mm



7. Technical data

Power supply		Rated voltage	AC 230 V
		Overvoltage category	III
		Frequency	50/60 Hz
		Power consumption	Max. 7VA / 3.7 W
	Caution 	No internal fuse! External preliminary protection with max C 10 A circuit breaker required in all cases.	
Outputs		Fan control Q1, Q2, Q3-N	AC 230 V
		Rating	5 mA...5(2) A
	 Note!	Fans must NOT be connected in parallel! Connect one fan directly, for additional fans, one relay for each speed.	
		Control output Y11-N / Y21-N (N.O.)	AC 230 V
		Rating	5 mA...5(2) A
	Caution 	No internal fuse! External preliminary protection with max C 10 A circuit breakers in the supply line required in all cases.	
Inputs		Multifunctional input X1-M/X2-M **)	
		Temperature sensor input:	
		Type	NTC (3 kΩ at 25 °C)
		Temperature range	0...49 °C
		Cable length	Max. 80 m
		Digital input:	
		Operating action	Selectable (NO / NC)
		Contact sensing	SELV DC 0...5 V / max 5 mA
		Parallel connection of several thermostats for one switch	Max. 20 thermostats per switch
		Insulation against mains voltage (SELV)	4 kV, reinforced insulation
	Function of inputs: **)	Selectable	
	External temperature sensor, heating/cooling changeover sensor, operating mode switchover contact, dew point monitor contact, enable electrical heater contact, fault contact, monitoring input	X1: P38 X2: P40	
Modbus		Interface type	RS485 Modbus RTU, Wire (ref.): 16 AWG, 1 pair, shielded serial line with 1.5 mm ² and length < 1200 m
		Bus current	Max. 50 mA
		Modbus topology:	See Modbus manual (MODBUS over serial line specification and implementation guide from http://www.modbus.org).

Operational data	Switching differential, adjustable	
	Heating mode (P30)	2 K (0.5...6 K)
	Cooling mode (P31)	1 K (0.5...6 K)
	Setpoint setting and range	
	☀ Comfort (P08)	21 °C (5...40 °C)
	Ⓢ Economy (P11-P12)	15 °C/30 °C (OFF, 5...40 °C)
	Ⓛ Protection (P11-P12)	8 °C/OFF (OFF, 5...40 °C)
	Multifunctional input X1/X2 **)	Selectable 0...8
	Input X1 default value (P38)	3 (Op. Mode switchover)
	Input X2 default value (P40)	1 (External temp. sensor)
	Built-in room temperature sensor	
	Measuring range	0...49 °C
	Accuracy at 25 °C	< ± 0.5 K
	Temperature calibration range	± 3.0 K
	Settings and display resolution	
Setpoints	0.5 °C	
Current temperature value displayed	0.5 °C	
Environmental conditions	Storage	As per IEC 60721-3-1
	Climatic conditions	Class 1K3
	Transport	As per IEC 60721-3-2
	Climatic conditions	Class 2K3
Operation	As per IEC 60721-3-3	
	Climatic conditions	Class 3K5 ¹⁾
Standards and directives	EU Conformity (CE)	CE1T3079xx *)
	RCM	A5W90002895 *)
	Electronic control type	2.B (micro-disconnection on operation)
	Home and Building Electronic Systems	EN 50090-2-2
	Safety class	II as per EN 60730
	Pollution class	Normal
	Housing flammability class according to UL94	V-0
	Degree of protection of housing	IP 30 as per EN 60529
Environmental compatibility	The product environmental declaration CE1E3079en (RDF302) *, A5W00085839A (RDF302/VB) *, A6V11610192 (RDF302.B) *) contains data on environmentally compatible product design and assessments (RoHS compliance, materials composition, packaging, environmental benefit, disposal).	
General	Connection terminals	Solid wires or prepared stranded wires 1 x 0.4...1.5 mm ²
	Housing front color	RAL 9003 white RAL 9004 black
	Weight without / with packaging	0.174 kg/0.261 kg

*) The documents can be downloaded from <http://siemens.com/bt/download>.

**) RDF302.B does not have inputs X1 and X2. Parameters related to X1 and X2 input functions are not applicable to RDF302.B.

¹⁾ No condensation is allowed.

Index

1	
1-speed fan	35
3	
3-position control signal	32
3-speed fan	35
A	
Applications overview	16
Automatic heating / cooling changeover	20, 23
Automatic heating / cooling changeover via bus ..	20
B	
Basic application	29
C	
Changeover switch	20
Chilled / heated ceiling applications	29
Clean fan filter reminder	36
Compressor applications	16, 29
Control outputs configuration	33
Control outputs overview	32
Control parameters	47
Control sequences	23
Cooling sequence	23
D	
Dew point monitoring	22, 38
Disposal	54
E	
Electric heater	25
Enable / disable electric heater	25, 38
Expert level parameters	47
External / return air temperature	37
External / return air temperature sensor	21
F	
Fan kick function	35
Fan minimum on-time	35
Fan operation as per heating / cooling mode, or disabled	35
Fan operation in dead zone	35
Fan overrun	36
Fan start	35
Fault	38
Fault on KNX	40
Fault, handling	39
Floor cooling	21
Floor heating	21
Floor temperature limitation function	21
H	
Heating / cooling changeover	20, 37
Heating and cooling sequence	23
Heating sequence	23
I	
Integral action time	10
K	
Key lock	22
M	
Main and secondary	27
Manual heating / cooling changeover	20
Manually select heating or cooling sequence	23
Minimum output	21
Moisture	21
Mounting and installation	51
Multifunctional inputs	37
O	
ON/OFF control signal	32
Operating mode	
Priority intervention	12
Operating mode button	12
Operating mode switchover	38
P	
Parameter setting	47
Proportional band	10
Protection mode / Standby	11
Purge function	21
R	
Radiator applications	29
Remote heating / cooling changeover	20
Reset parameters	47
S	
Setpoint Comfort mode	30
Setpoint Economy mode	30
Setpoint limitation	13
Setpoint Protection mode	30
Setpoints and sequences	30
Standby / Protection mode	11
Switching differential	10
Synchronization	33

T
Temperature out of range..... 39
Temporary setpoint 13

U
Universal applications 16

W
Window contact.....13
Window state..... 11, 38

Issued by
Siemens Switzerland Ltd
Smart Infrastructure
Global Headquarters
Theilerstrasse 1a
CH-6300 Zug
Tel. +41 58 724 2424
www.buildingtechnologies.siemens.com

© Siemens Switzerland Ltd, 2011 (-2022)
Technical specifications and availability subject to change without notice.