

# SIEMENS



RDF300, RDF300.02  
RDF340, RDF600



RDF300.02/VB



RDF400.01, RDF600T

## Flush-mounted room thermostats for Fan coils, with LCD

**RDF300... / RDF340... / RDF400... / RDF600...**

### Basic Documentation

Edition 5.0

CE1P3076en  
2023-12-07

**Smart Infrastructure**

# Table of contents

<b>1</b>	<b>About this document</b> .....	<b>4</b>
1.1	Revision history .....	4
1.2	Reference documents .....	4
1.3	Before you start .....	4
1.3.1	Copyright .....	4
1.3.2	Quality assurance .....	4
1.3.3	Document use / request to the reader .....	5
<b>2</b>	<b>Summary</b> .....	<b>6</b>
2.1	Brief description .....	6
2.2	Features .....	6
2.3	Type summary .....	7
2.4	Equipment combinations .....	8
2.5	Accessories .....	9
<b>3</b>	<b>Use</b> .....	<b>9</b>
<b>4</b>	<b>Functions</b> .....	<b>10</b>
4.1	Temperature control .....	10
4.2	Operating modes .....	11
4.3	Room temperature setpoints .....	12
4.4	Applications .....	13
4.4.1	Applications for fan coil systems .....	13
4.4.2	Applications for Universal systems .....	14
4.4.3	Applications for heat pump systems .....	15
4.5	Additional features .....	16
4.6	Control sequences .....	18
4.6.1	2-pipe fan coil unit .....	19
4.6.2	2-pipe fan coil unit with electrical heater .....	20
4.6.3	4-pipe fan coil unit .....	22
4.7	Control outputs .....	24
4.8	Fan control .....	25
4.9	Multifunctional input .....	28
4.10	Auto Timer (RDF400... / RDF600T only) .....	29
4.11	Error handling .....	31
4.12	Infrared remote control .....	31
4.13	DIP switches .....	32
4.14	Control parameters .....	32
<b>5</b>	<b>Handling</b> .....	<b>35</b>
5.1	Mounting and installation .....	35
5.2	Operating Instructions .....	36
5.3	Disposal .....	36
<b>6</b>	<b>Engineering</b> .....	<b>37</b>
6.1	Connection terminals .....	37
6.2	Connection diagrams .....	38
6.2.1	Water-based fan coil applications with RDF300... / RDF400... / RDF600... .....	38
6.2.2	Compressor-based applications with RDF300... / RDF400... / RDF600... .....	39

6.2.3	Water-based fan coil applications with RDF340...	40
<b>7</b>	<b>Mechanical design</b>	<b>41</b>
7.1	Dimensions	42
<b>8</b>	<b>Technical data</b>	<b>43</b>
<b>Index</b>	<b>45</b>	

# 1 About this document

## 1.1 Revision history

Edition	Date	Changes	Section	Pages
5.0	2023-12-07	<ul style="list-style-type: none"><li>Update info about "Floor heating temperature limit"</li></ul>	2.2, 4.5, 4.14	6, 17, 34
4.0	2020-02-21	<ul style="list-style-type: none"><li>Added RDF300.02/VB</li></ul>		1, 6
3.0	2014-10-15	<ul style="list-style-type: none"><li>Update overcurrent protection from a fuse to a circuit breaker;</li><li>Update the notation for valves;</li><li>Update the warning for wiring and mounting;</li><li>Update the standards and directives for RoHS 2.0.</li></ul>	4.4 4.6 5.1 6.2 8	13 18 35 38 43
2.0	Oct 2012	Added RDF600...	All	All
1.1	28 Aug 2008	Left column in table	4.4 Applications	13
1.0	10 July 2008	First edition		

## 1.2 Reference documents

Ref.	Document title	Type of document	Document No.
N3076	Flush-mounted room temperature controllers with LCD	Datasheet	CE1N3076
B3076	Operating instructions		CE1B3076...
M3076	Mounting instructions RDF3... RDF400		CE1M3076
M3163	Mounting instructions RDF600...		CE1M3163

## 1.3 Before you start

### 1.3.1 Copyright

---

This document may be duplicated and distributed only with the express permission of Siemens, and may be passed only to authorized persons or companies with the required technical knowledge.

### 1.3.2 Quality assurance

These documents have been prepared with great care:

- The contents of all documents are checked at regular intervals
- Any corrections necessary are included in subsequent versions
- Documents are automatically amended as a consequence of modifications and corrections to the products described

Please ensure that you are aware of the latest revision date of the documentation. If you find lack of clarity while using this document, or if you have any criticisms or suggestions, please contact the Product Manager in your nearest branch office.

The addresses of the Siemens Regional Companies are available at

[www.buildingtechnologies.siemens.com](http://www.buildingtechnologies.siemens.com).

### 1.3.3 Document use / request to the reader

---

Before using our products, it is important that you read the documents supplied with or ordered at the same time as the products (equipment, applications, tools, etc.) carefully and in full.

We assume that persons using our products and documents are authorized and trained appropriately and have the technical knowledge required to use our products as intended.

More information on the products and applications is available:

- On the intranet (Siemens employees only) at <https://workspace.sbt.siemens.com/content/00001123/default.aspx>
- From the Siemens branch office near you [www.buildingtechnologies.siemens.com](http://www.buildingtechnologies.siemens.com) or from your system supplier
- From the support team at headquarters [fieldsupport-zug.ch.sbt@siemens.com](mailto:fieldsupport-zug.ch.sbt@siemens.com) if there is no local point of contact

Siemens assumes no liability to the extent allowed under the law for any losses resulting from a failure to comply with the aforementioned points or for the improper compliance of the same.

## 2 Summary

### 2.1 Brief description

---

The devices support:

- 2-pipe, 2-pipe with electrical heater and 4-pipe fan coil units
- Compressors in DX-type equipment
- **RDF300... / RDF400... / RDF600...:**
  - AC 230 V operating voltage, on/off or 3-position control outputs
- **RDF340** AC 24 V operating voltage, DC 0...10 V control outputs
- Output for 3-speed or 1-speed fan
- Two multifunctional inputs for keycard contact, external sensor, etc.
- Operating modes: Comfort, Economy and Protection
- Automatic or manual heating/cooling changeover
- Adjustable commissioning and control parameters
- Minimum and maximum setpoint limitation

#### Additional features

- **Backlit LCD** (RDF300.02, RDF300.02/VB, RDF400.01, RDF600, RDF600T)
- **Infrared remote control receiver** (RDF400.01, RDF600T)
- **Auto Timer mode with 8 programmable timers** (RDF400.01, RDF600T)

#### Type of mounting / suitable conduit boxes

- **RDF600...** for Round CEE box, with min 60 mm diameter, min 40 mm depth
- **RDF3... / RDF400...** for recessed square box with 60.3 mm fixing centers

### 2.2 Features

---

- Maintain room temperature via built-in temperature sensor or external room temperature / return air temperature sensor
- Automatic or manual changeover between heating and cooling mode
- Select applications via DIP switches
- Select operating mode via the operating mode button on the controller
- Single or 3-speed fan control (automatic or manual)
- Display current room temperature or setpoint in °C and/or °F
- Minimum and maximum setpoint limitation
- Keypad lock (automatic and manual)
- Two multifunctional inputs, freely selectable for:
  - Operating mode switchover contact (key card)
  - Automatic heating/cooling changeover sensor
  - External room temperature or return air temperature
  - Dewpoint sensor
  - Electrical heater enable
  - Alarm input
- Advanced fan control function, i.e. fan kick, fan start, selectable fan operation (enable, disable or depending on heating or cooling mode)
- Purge function together with 2-port valve in a 2-pipe changeover system
- Reminder to clean filters
- Floor heating temperature limit (RDF300..., RDF400..., RDF600...)
- Reload factory settings for commissioning and control parameters
- Weekly time program: 8 programmable timers to switch over between Comfort and Economy mode (RDF400.01 / RDF600T)

- Optional backlit LCD (RDF300.02 / RDF300.02/VB / RDF400.01 / RDF600 / RDF600T)
- Optional infrared remote control (RDF400.01 / RDF600T)

## 2.3 Type summary





















Product number	Stock number	Features								Color
		Operating Voltage	Control outputs			Time program	Backlit LCD	Infrared receiver <sup>1)</sup>	Suitable conduit box <sup>2)</sup>	
			on/off	3pt	DC 0...10V					
<b>RDF300</b>	RDF300	AC 230V	✓	✓					square	White
<b>RDF300.02</b>	RDF300.02	AC 230V	✓	✓			✓		square	White
<b>RDF300.02/VB</b>	S55770-T427	AC 230 V	✓	✓			✓		square	Black
<b>RDF400.01</b>	RDF400.01	AC 230V	✓	✓		✓	✓	✓	square	White
<b>RDF340</b>	RDF340	AC 24V			✓				square	White
<b>RDF600</b>	S55770-T291	AC 230V	✓	✓			✓		round	White
<b>RDF600T</b>	S55770-T292	AC 230V	✓	✓		✓	✓	✓	round	White

1) Infrared remote control is to be ordered as separate item

2) Square conduit box e.g. ARG71. ,

Round conduit box min 60 mm diameter and min 40 mm depth



## 2.4 Equipment combinations

	Type of unit	Product number	Data sheet <sup>*)</sup>
	Cable temperature sensor or changeover sensor, cable length 2.5 m NTC (3 kΩ at 25 °C)	 QAH11.1	1840
	Room temperature sensor NTC (3 kΩ at 25 °C)	 QAA32	1747
	Cable temperature sensor, cable length 4 m NTC (3 kΩ at 25 °C)	 QAP1030/UFH	1854
	Condensation monitor	 QXA21..	A6V10741 072
<i>on/off actuators</i>	Electromotoric ON/OFF actuator	 SFA21...	4863
	Electromotoric ON/OFF valve and actuator (only available in AP, UAE, SA and IN)	 MVI.../MXI...	4867
	Zone valve actuators (only available in AP, UAE, SA and IN)	 SUA...	4832
	Thermal actuator (for radiator valve)	 STA23...	4884
	Thermal actuator (for small valves 2.5 mm)	 STP23...	4884
<i>3-position actuators</i>	Electrical actuator, 3-position (for radiator valve)	 SSA31...	4893
	Electrical actuator, 3-position (for small valve 2.5 mm)	 SSP31...	4864
	Electrical actuator, 3-position (for small valve 5.5 mm)	 SSB31...	4891
	Electrical actuator, 3-position (for 2- and 3-port valves / V...P45)	 SSC31...	4895
<i>DC 0...10 V actuators</i>	Electrical actuator, DC 0...10 V (for radiator valves)	 SSA61..	4893
	Electrical actuator, DC 0...10 V (for 2- and 3-port valves/V...P45)	 SSC61..	4895
	Electrical actuator, DC 0...10 V (for small valves 2.5 mm)	 SSP61..	4864
	Electrical actuator, DC 0...10 V (for small valves 5.5 mm)	 SSB61..	4891
	Electromotoric actuator, DC 0...10 V (for valves 5.5 mm)	 SAS61..	4581
	Electromotoric actuator, DC 0...10 V (for valves 5.5 mm)	 SAT61..	4584
	Electrothermal actuator, AC 24 V, NC, DC 0...10 V, 1 m	 STA63	4884
	Electrothermal actuator, AC 24 V, NO, DC 0...10 V, 1 m	 STP63	4884

<sup>\*)</sup> The documents can be downloaded from <http://siemens.com/bt/download>.



## 2.5 Accessories

Designation		Product no.	Data Sheet
Changeover mounting kit (50 pcs/package)		<b>ARG86.3</b>	N3009
Plastic mounting spacer for flush-mounted thermostats RDF3... RDF400... for increasing the headroom in the conduit box by 10 mm		<b>ARG70.3</b>	N3009
Conduit box for flush-mounted thermostat RDF3... RDF400...		<b>ARG71 / S55770-T137</b>	N3009

## 3 Use

To control the room temperature in individual rooms and zones that are:

- Heated or cooled with 2-pipe fan coil units
- Heated or cooled with 2-pipe fan coil units with electrical heater
- Heated and cooled with 4-pipe fan coil units
- Heated or cooled with compressor in DX-type equipment
- Heated or cooled with compressor in DX-type equipment with electrical heater
- Heated and cooled with compressor in DX-type equipment

The RDF300.../RDF400... / RDF600... controls:

- One single or 3-speed fan
- One or two on/off valve actuators
- One on/off valve actuator and one 1-stage electrical heater
- One 3-position valve actuator
- One 1-stage compressor in DX-type equipment or one 1-stage compressor with electrical heater

The RDF340... controls:

- One single or 3-speed fan
- One or two DC 0...10 V valve actuators
- One DC 0...10 V valve actuators and one modulating electrical heater (DC 0...10 V)

Use in systems with:

- Heating or cooling mode
- Automatic heating/cooling changeover
- Manual heating/cooling changeover
- Heating and cooling mode (e.g. 4-pipe system)

# 4 Functions

## 4.1 Temperature control

---

### General note

The setting of the control parameters (P01 etc., mentioned throughout the document) is described in section 4.14.

The controller acquires the room temperature via built-in sensor, external room temperature sensor (QAA32), or external return air temperature sensor (QAH11.1), and maintains the setpoint by issuing actuator control commands to heating and/or cooling equipment. The following control outputs are available depending on the controller type:

- On/off control (2-position) with **RDF300.../RDF400... / RDF600...**
- Modulating PI control with 3-position control output on **RDF300.../RDF400... / RDF600...**
- Modulating PI control with DC 0...10 V control output on **RDF340**

The switching differential or proportional band is 2 K for heating mode and 1 K for cooling mode (adjustable via parameters P30 and P31).





The integral action time for continuous PI control is 5 minutes (adjustable via parameter P35).

### Display

The display shows the acquired room temperature or the setpoint for the current operating mode, selectable via parameter P06. The factory setting displays the current room temperature.

Use parameter P04 to display the room temperature or setpoint in °F rather than °C as needed.



If the controller is used in a system with manual heating/cooling changeover (P01=2), the heating  and cooling  symbols on the display show the fan coil or terminal unit status. Thus, the symbols are displayed even when the controller operates in the neutral zone. For all other cases, the heating  and cooling  symbols are displayed when the heating or cooling output is energized.

### Concurrent display of °C and °F

Concurrent display of the current temperature or setpoint in °C and in °F (parameter P07) is possible on the controller without weekly time program.

## 4.2 Operating modes

---

Select the controller's operating mode via operating mode button  on the controller or operating mode input (e.g. keycard occupancy sensor, when X1 or X2 set to 3 (P38, P40)). A corresponding setpoint is used to maintain the room temperature at the desired level depending on the active operating mode. The following operating modes are available:

### Comfort mode



In Comfort mode, the controller maintains the setpoint which can be adjusted via the +/- buttons. The fan can be set to automatic or manual fan speed: Low, medium or high.

### Economy



Economy mode helps save energy. Select it by pressing the operating mode button  if parameter P02 is set accordingly, or if the external operating mode switchover contact is active (e.g. window contact).

### Note

If the external operating mode switchover contact is active, user operations are ineffective and "OFF" is displayed. Control will then be according to Economy setpoints (P11 and P12).

### Protection mode







In Protection mode, the system is

- protected against frost (factory setting **8°C**, can be disabled or changed via P65)
- protected against overheating (factory setting **OFF**, can be enabled or changed via P66)

### Auto Timer mode



(only with RDF400... ,  
RDF600T)

In Auto Timer mode , the controller automatically changes from Comfort to Economy mode as per the 8 preprogrammed timers. The display shows the Auto Timer mode symbol  along with the symbol for the current operating mode (Comfort  or Economy .

Automatic is the default fan speed in Auto Timer mode.

## 4.3 Room temperature setpoints

### Comfort mode

#### Setpoint limitation

The setpoint in Comfort mode can be adjusted via the +/- buttons.

For energy saving purposes, the setpoint adjusting range can be limited to minimum (P09) and maximum (P10).

P09 < P10

- If the minimum limit **P09 is set lower** than the maximum limit P10, both heating and cooling are adjustable between these two limits.

P09 ≥ P10

- For heating **or** cooling applications (e.g. 2-pipe)
  - The setting range in cooling mode is from **P09...40°** instead of 5...40°
  - The setting range in heating mode is from **5...P10°** instead of 5...40°
- For heating **and** cooling applications (e.g. 4-pipe)
  - **P09** is the setpoint for cooling and **P10** the setpoint for heating;
  - the setpoint can no longer be adjusted via the +/- buttons

Examples	2-pipe Heating OR cooling	4-pipe Heating AND cooling
P09 < P10	<p>5°C      18°C      25°C      40°C</p> <p>          P09      P10</p> <p>Cooling setpoint adjustable 18...25°C Heating setpoint adjustable 18...25°C</p>	<p>5°C      18°C      25°C      40°C</p> <p>          P09      P10</p> <p>Cooling setpoint adjustable 18...25°C Heating setpoint adjustable 18...25°C</p>
P09 ≥ P10	<p>5°C      21°C      25°C      40°C</p> <p>          P10      P09</p> <p>Cooling settable 25...40°C Heating settable 5...21°C</p>	<p>Cooling fixed = 25°C (P09) Heating fixed = 21°C (P10)</p>

#### Temporary setpoint

If the "Temporary setpoint function" is enabled via parameter P69, the setpoint adjusted via the +/- buttons is set back to the Comfort basic setpoint when the operating mode changes.

The factory setting for the Comfort basic setpoint is **21 °C** and can be changed via parameter P08.

### Economy mode

Use control parameters P11 and P12 to adjust the Economy mode setpoints.

The heating setpoint is factory-set to **15 °C** and to **30 °C** for cooling.

### Protection mode

Use control parameters P65 and P66 to adjust the Protection mode setpoints.

The heating setpoint is factory-set to **8 °C** (frost protection) and to **OFF** for cooling.

#### Caution









If a setpoint is set to OFF (P65, P66), the controller does not maintain the setpoint in the corresponding mode (heating or cooling).

This means no protective heating or cooling function and thus risk of frost in the heating mode or risk of overheat in cooling mode!

## 4.4 Applications

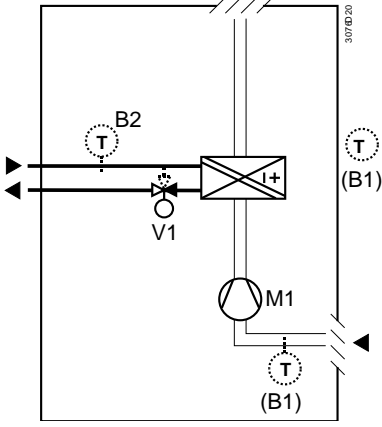
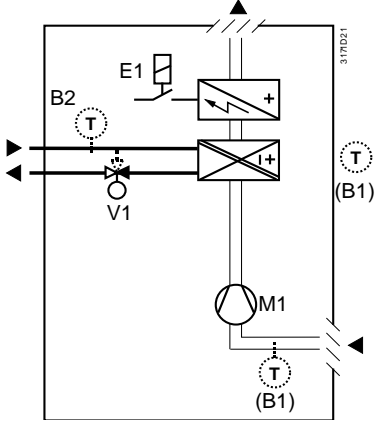
The controller supports following applications, which can be configured by DIP switches on the inner side of the controller front panel. Depending on the type, on/off or modulating control outputs are available.

### 4.4.1 Applications for fan coil systems

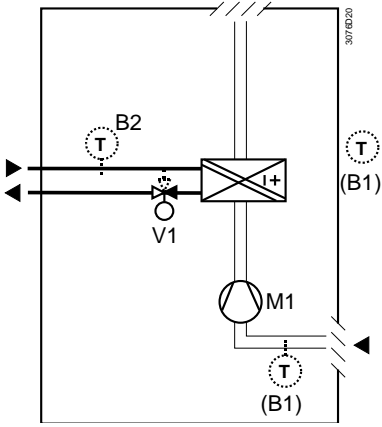
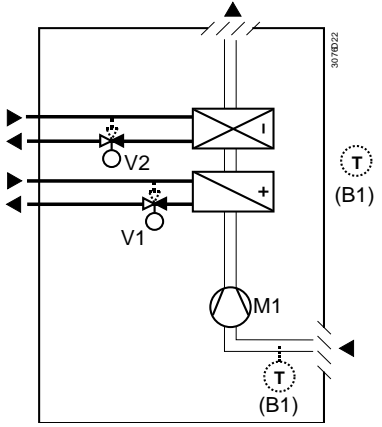





Application and output signal, DIP switches, diagram	
<ul style="list-style-type: none"> <li>• <b>2-pipe fan coil unit ON/OFF</b> (heating <b>or</b> cooling)</li> </ul>  <p>RDF300... RDF400... RDF600...</p>	<ul style="list-style-type: none"> <li>• <b>2-pipe fan coil unit ON/OFF</b> (heating <b>or</b> cooling) with electrical heater</li> </ul>  <p>RDF300... RDF400... RDF600...</p>
<ul style="list-style-type: none"> <li>• <b>2-pipe fan coil unit modulating, DC 0...10 V</b> (heating <b>or</b> cooling)</li> </ul>  <p>RDF340</p>	<ul style="list-style-type: none"> <li>• <b>2-pipe fan coil unit modulating, DC 0...10 V</b> (heating <b>or</b> cooling) with electrical heater</li> </ul>  <p>RDF340</p>
	
<ul style="list-style-type: none"> <li>• <b>2-pipe fan coil unit modulating, 3-position</b> (heating <b>or</b> cooling)</li> </ul>  <p>RDF300... RDF400... RDF600...</p>	<ul style="list-style-type: none"> <li>• <b>4-pipe fan coil unit ON/OFF</b> (heating <b>and</b> cooling)</li> </ul>  <p>RDF300... RDF400... RDF600...</p>  <p>RDF340</p>
	

V1 Heating or heating/cooling valve actuator  
V2 Cooling valve actuator

E1 Electrical heater

M1 3-speed or single-speed fan  
B1 Return air temperature sensor or external room temperature sensor (optional)  
B2 Changeover sensor (optional)

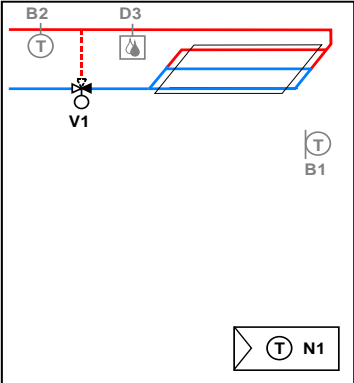
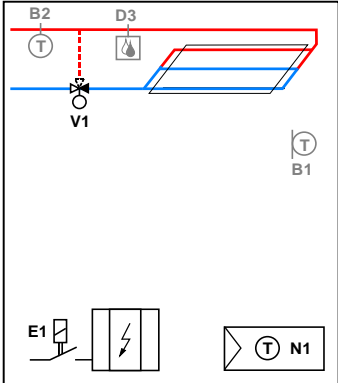
## 4.4.2 Applications for Universal systems

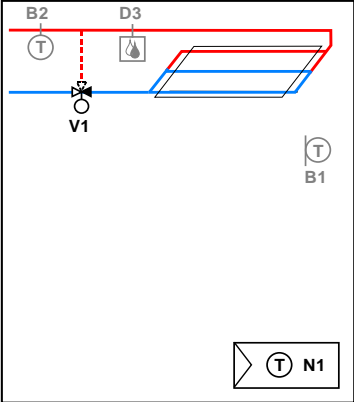
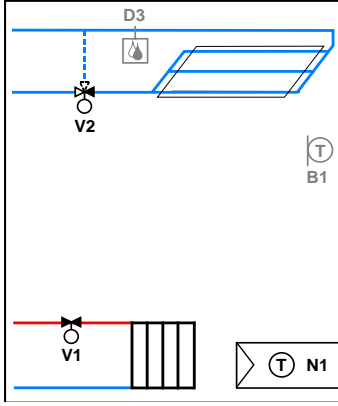
Application and output signal, DIP switches, diagram					
<ul style="list-style-type: none"> <li>• <b>Chilled / heated ceiling ON/OFF</b> (heating <b>or</b> cooling)</li> </ul>		RDF300... RDF400... RDF600...	<ul style="list-style-type: none"> <li>• <b>Chilled / heated ceiling ON/OFF</b> (heating <b>or</b> cooling) with electrical heater</li> </ul>		RDF300... RDF400... RDF600...
<ul style="list-style-type: none"> <li>• <b>Chilled / heated ceiling modulating, DC 0...10 V</b> (heating <b>or</b> cooling)</li> </ul>		RDF340	<ul style="list-style-type: none"> <li>• <b>Chilled / heated ceiling modulating, DC 0...10 V</b> (heating <b>or</b> cooling) with electrical heater</li> </ul>		RDF340
 <p>3191S11</p>			 <p>3191S12</p>		
<ul style="list-style-type: none"> <li>• <b>Chilled / heated ceiling modulating, 3-position</b> (heating <b>or</b> cooling)</li> </ul>		RDF300... RDF400... RDF600...	<ul style="list-style-type: none"> <li>• <b>Chilled ceiling and radiator ON/OFF</b> (heating <b>and</b> cooling)</li> </ul>		RDF300... RDF400... RDF600...
 <p>3191S11</p>			 <p>3191S13</p>		

V1 Heating or heating / cooling valve actuator

V2 Cooling valve actuator

E1 Electrical heater

B1 Return air temperature sensor or external room temperature sensor (optional)

B2 Changeover sensor (optional)

D3 Dewpoint sensor

### 4.4.3 Applications for heat pump systems

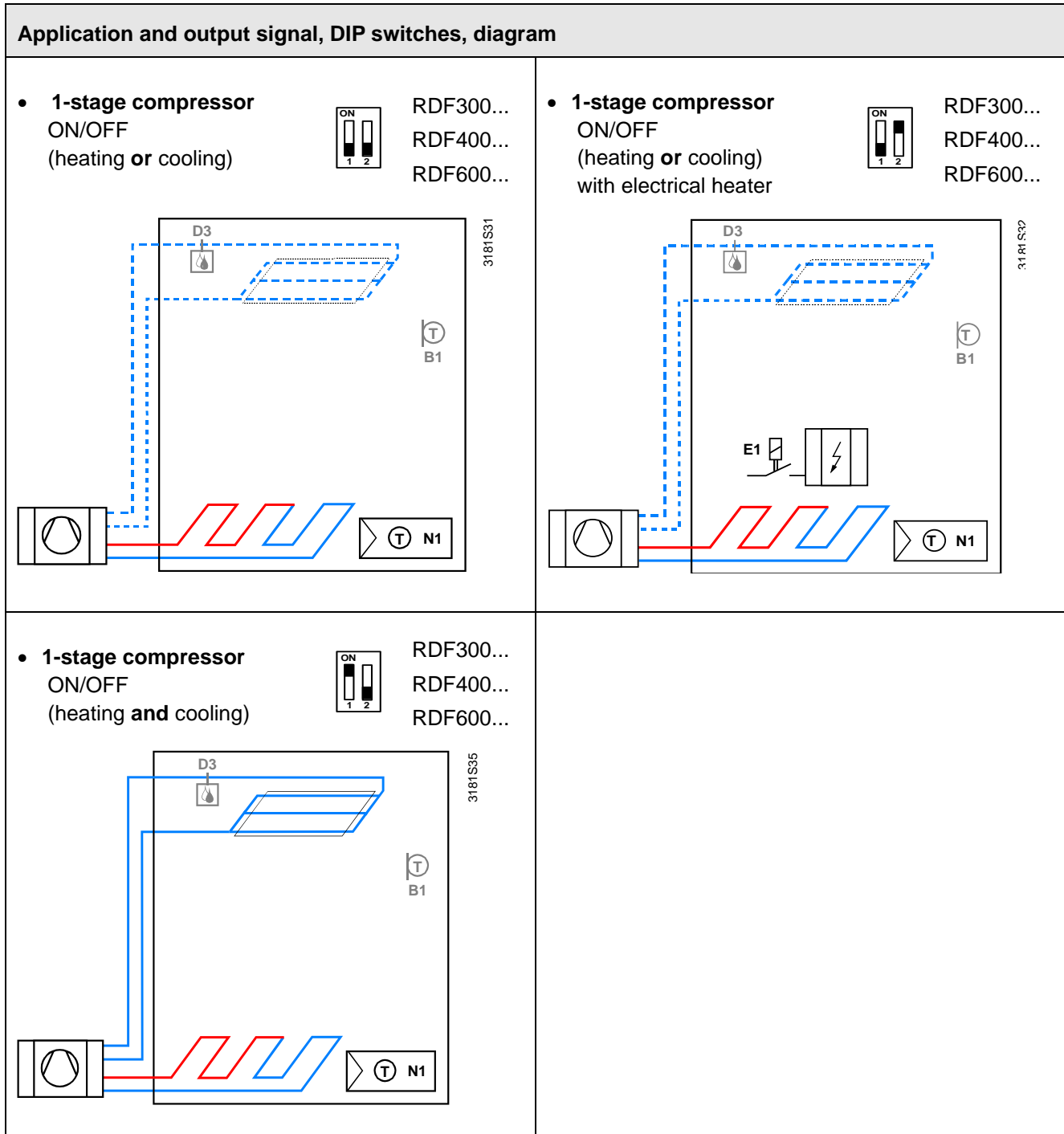

N1 Thermostat  
Terminal Y10/Y11: Heating (H&C) or Heating/Cooling  
Terminal Y20/Y21: Cooling (H&C)

E1 Electrical heater

B1 Return air temperature sensor or external room temperature sensor (optional)

D3 Dewpoint sensor

Note: The diagrams above show only the water based fan coil application, but not compressor!

#### Water-based fan coil application

Use with one or two valves for heating and cooling, heating/cooling with changeover, heating only, or cooling only.

## Compressor-based application

Use with one 1-stage compressor for heating and cooling, or cooling only, or heating only.

## Universal applications

Thanks to a flexible fan control, the RDF3xx / RDF4xx can also be used in universal applications, e.g. fan coil-based cooling and floor heating, or chilled ceiling and electrical heater etc. See also section 4.8 “Fan control”.

## 4.5 Additional features

### Automatic H/C changeover

The water temperature acquired by the changeover sensor (QAH11.1 + ARG86.3) is used to change over from heating to cooling mode and vice-versa. When the water temperature is above 28 °C (parameter P37), the controller changes over to heating mode, and to cooling mode when below 16 °C (parameter P36). If the water temperature is between the 2 changeover points immediately after power up, the controller starts in previous mode.

The water temperature is acquired at 30-second intervals and the operating state is updated accordingly.

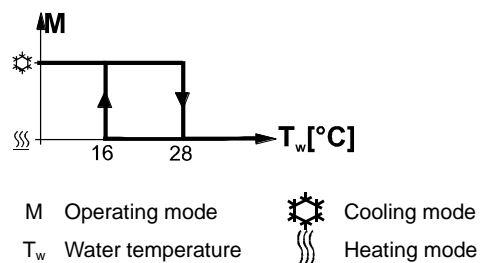

### Remote heating/cooling changeover

The QAH11.1 cable temperature sensor for automatic heating/cooling changeover can be replaced by an external switch for manual, remote changeover:

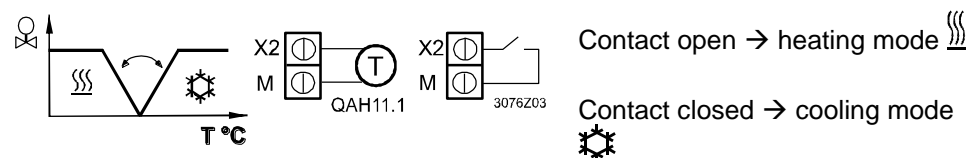

The sensor or switch can be connected to the input terminal of X2 (factory setting) or X1 depending on the commissioning of inputs X1 and X2. See also section 4.9 “Multifunctional input”.

### External / return air temperature sensor

The controller acquires the room temperature via built-in sensor, external room temperature sensor (QAA32), or external return air temperature sensor (QAH11.1) connected to multifunctional input X1 or X2.

Inputs X1 or X2 need to be commissioned accordingly. See section 4.9 “Multifunctional input”.

### Purge function

The changeover sensor is tasked with initiating changeover from heating to cooling mode based on the acquired water temperature. We recommend activating the purge function (parameter P50) with 2-port valves. This function ensures correct acquisition of the medium temperature even if the 2-port valve is closed for an extended period of time. The valve is then opened for 1 to 5 minutes (adjustable) at 2-hour intervals during off-hours.

Caution

The purge function (parameter P50) must be disabled if the controller is to be used in compressor-based applications.



**Avoid damage from moisture**

In very warm and humid climates, the fan can be run periodically or continuously at a low fan speed (e.g. in empty apartments or shops) in Economy mode by setting parameter P61 to avoid damage from moisture due to a lack of air circulation. See also section 4.8 "Fan control", under "Fan kick function".

**Minimum output on-time/off-time**

Limit the on/off switching cycle to protect the compressor and reduce wear and tear. The minimum output on-time and off-time for 2-position control output Y11/Y21 can be adjusted from 1 to 20 minutes via parameters P48 and P49. The factory setting is 1 minute  
Readjusting the setpoint or heating/cooling mode changeover immediately results in calculation of the output status; controller output Y11/Y21 may not hold the min. 1-minute on/off time.  
If parameter P48 or P49 is set to above 1 minute, the min. on/off time for Y11 is maintained as set, even if setpoint or changeover mode is readjusted.  
This function is only available for on/off control.

**Floor heating limitation function (RDF300..., RDF400..., RDF600...)**

The floor heating limitation function is a part of the floor heating application (heating with fan disabled).  
The floor temperature sensor, connected to multifunctional input X1 or X2, measures the floor temperature. If the temperature exceeds the parameterized limit (parameter P51), the heating valve is fully closed until the floor temperature drops to 2K below the parameterized limit.  
This function is factory-set to OFF (disabled).  
Input X1 or X2 must be commissioned accordingly (P38 or P40 = 1).  
See section 4.9 "Multifunctional input".

Parameter P51	External temperature sensor available	Source for display of room temperature	Output control according to	Floor temp. limit function
OFF	No	Built-in sensor	Built-in sensor	Not active
OFF	Yes	External temp	External temp. sensor	Not active
10...50°C	No	Built-in sensor	Built-in sensor	Not active
10...50°C	Yes	Built-in sensor	Built-in sensor + limit by external sensor	Active

**Dewpoint monitoring**

Dewpoint monitoring is essential to prevent condensation on the chilled ceiling (cooling with fan disabled). It helps to avoid associated damage to the building. A dewpoint sensor with a voltage-free contact is connected to multifunctional input X1 or X2. If there is condensation, the cooling valve is fully closed until no more condensation is detected, and the cooling output is disabled temporarily.  
The condensation symbol  is displayed during temporary override.  
Input X1 or X2 must be commissioned accordingly.  
See section 4.9 "Multifunctional input".

**Key lock**

If the key lock function is enabled by parameter P14, then the keypad will be locked or unlocked by pressing 7 seconds (RDF600...: 3 seconds) on the operating mode button .  
If "Auto lock" is configured, then the controller will automatically lock the keypad 30 seconds after the last adjustment.

## 4.6 Control sequences

The controller can be used in systems featuring:

- Heating or cooling mode (P01=0 or P01=1)
- Manual heating/cooling changeover (P01=2)
- Automatic heating/cooling changeover (P01=3)
- Heating and cooling mode (e.g. 4-pipe system) (P01=4)

The relevant modes are available and can be adjusted via commissioning parameter “Control sequence” P01, depending on the selected application.

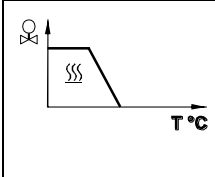
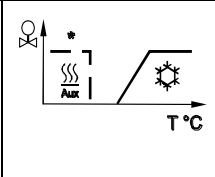
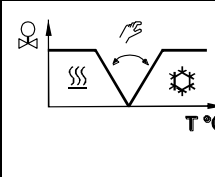
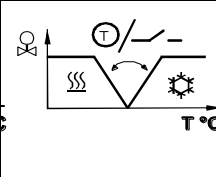
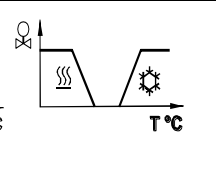
Sequence					
Parameter	P01 = 0	P01 = 1	P01 = 2	P01 = 3	P01 = 4
Mode	Heating mode	Cooling mode *) 2-pipe with el. heater	Manually select heating or cooling mode	Automatic heating/cooling changeover via external water temperature sensor or remote switch	Heating and cooling mode, i.e. 4-pipe
Available for:					
2-pipe, 2-pipe & el. heater	✓	✓	✓	✓	
4-pipe			✓	✓	✓

## 4.6.1 2-pipe fan coil unit

### On/off output Heating or cooling

In 2-pipe applications, the controller controls a valve in heating/cooling mode with changeover (automatic or manual), heating only mode, or cooling only mode. Cooling only is factory set (P01=1).

### Control sequence on/off output

The diagram below shows the control sequence for on/off (2-position) control.

#### Heating mode

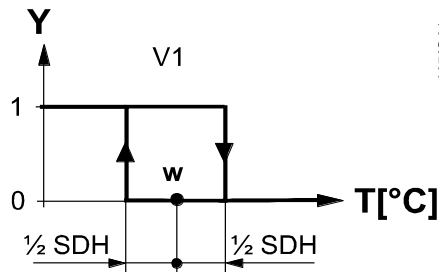

#### Cooling mode

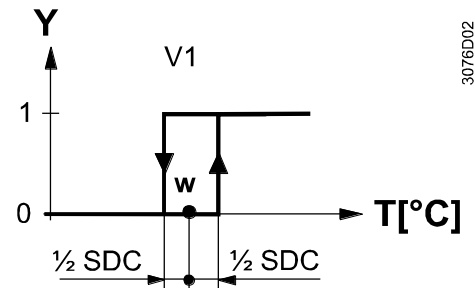

T[°C]	Room temperature	SDH	Switching differential "Heating"
w	Room temperature setpoint	SDC	Switching differential "Cooling"
V1	Control command "Valve" or "Compressor"		

### Control sequence modulating output

The diagram below shows the control sequence for continuous PI control.

#### Heating mode

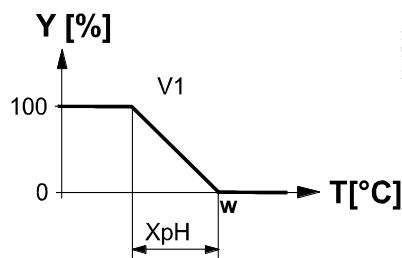

#### Cooling mode

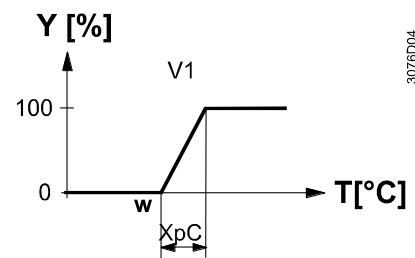

T[°C]	Room temperature	XpH	Proportional band "Heating"
w	Room temperature setpoint	XpC	Proportional band "Cooling"
V1	Control command "Valve"		

- Notes:
- The diagrams only show the PI thermostat's proportional part.
  - For the fan sequence see section 4.8.

## 4.6.2 2-pipe fan coil unit with electrical heater

### Heating or cooling with electrical heater

In 2-pipe applications with electrical heater, the controller controls a valve in heating/cooling mode with changeover, heating only mode, or cooling only mode plus auxiliary electrical heater. Cooling only is factory set (P01=1) with enabled electrical heater (P13).

### Electrical heating, active in cooling mode

In cooling mode, the valve receives an **OPEN** command if the acquired temperature is above the setpoint. The electrical heater receives an **ON** command if the acquired room temperature drops below “setpoint” – “dead zone” (=“setpoint for electrical heater”) while the electrical heater is enabled (parameter P13).

Note:

- “Setpoint for electrical heater” is limited by parameter “Maximum heating setpoint” (P10).
- When P52 (fan operation) = 2 (only in heating), fan is disabled in cooling mode. An external fan is required to avoid overheating of the electrical heater.

### Electrical heating in heating mode

In heating mode, the valve receives an **OPEN** command if the acquired temperature is below the setpoint. The electrical heater is used as additional heating source when the heating energy controlled by the valve is insufficient. The electrical heater receives an **ON** command, if the temperature is below “setpoint” – “setpoint differential” (=setpoint for electrical heater).

### Electrical heating, and manual changeover

The electrical heater is active in heating mode only and the control output for the valve is permanently disabled when manual changeover is selected (P01=2).

### Digital input “Enable electrical heater”

Remote enabling/disabling of the electrical heater is possible via digital input X1/X2 for tariff regulations, energy saving etc. Input X1 or X2 must be commissioned accordingly. See section 4.9 “Multifunctional input”.

### Control sequence on/off output

The diagram below shows the control sequence for on/off (2-position) control.

#### Heating mode

(automatic changeover=heating or heating only)

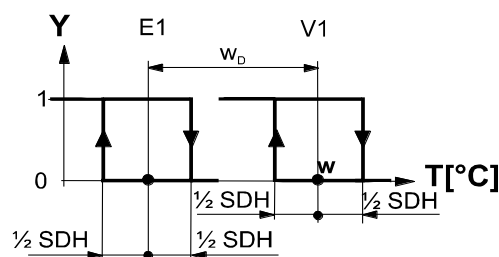

#### Cooling mode

(man. /auto. changeover=cooling or cooling only)

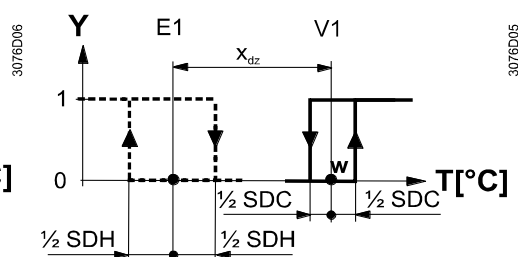

Heating mode with manual changeover  
(P01=2)  
(manual changeover=heating)

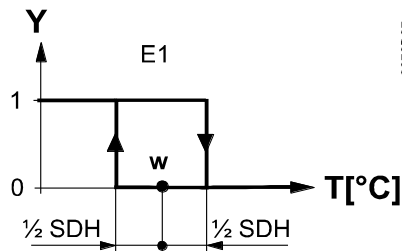

3076D07

- T[°C] Room temperature
- W Room temperature setpoint
- V1 Control command "Valve" or "Compressor"
- E1 Control command "electrical heater"
- SDH Switching differential "Heating"
- SDC Switching differential "Cooling"
- X<sub>dz</sub> Dead zone
- w<sub>D</sub> Setpoint differential

Note For better temperature control performance with 2-pos electrical heater, we suggest to set the switching differential heating (P30) to 1K.

Control sequence  
modulating output

The diagram below shows the control sequence for continuous PI control.

Heating mode

(automatic changeover=heating or heating only)

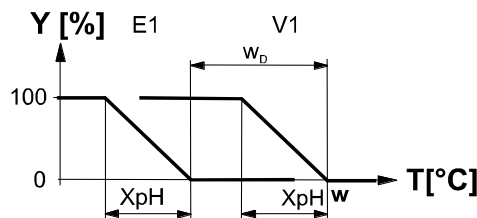

3076D09

Cooling mode

(man. /auto. changeover=cooling or cooling only)

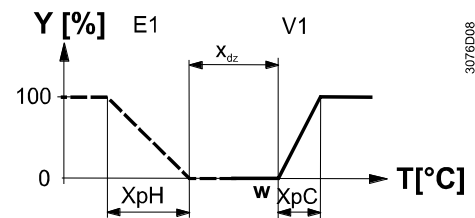

3076D08

Heating mode with manual changeover  
(P01=2)

(manual changeover=heating)

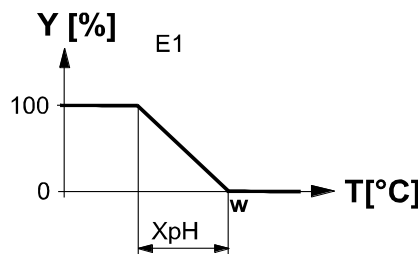

3076D10

- T[°C] Room temperature
- W Room temperature setpoint
- V1 Control command "Valve"
- E1 Control command "electrical heater"
- XpH Proportional band "Heating"
- XpC Proportional band "Cooling"
- X<sub>dz</sub> Dead zone
- w<sub>D</sub> Setpoint differential

- Notes:
- The diagrams only show the PI thermostat's proportional part.
  - For the fan sequence see section 4.8.

### 4.6.3 4-pipe fan coil unit

Heating and cooling

In 4-pipe applications, the controller controls two valves in heating and cooling mode, heating/cooling mode by manual selection, or heating and cooling mode with changeover. Heating and cooling mode (P01=4) is factory set.

4-pipe application with manual selection

The heating or cooling output can be released via operating mode selector button if parameter P01 is set to manual (P01=2).

“Main and Secondary” application (4-pipe with changeover)

The heating and cooling output is swapped per the sensor input status (see automatic heating and cooling changeover sensor), if parameter P01 is set to changeover (P01=3). This mode is used for “Main and Secondary” application, which equates to a 4-pipe fan coil unit system with different capacity for heating and cooling coils. The water circuit is changed to optimize the energy exchange depending on the season (summer/winter).

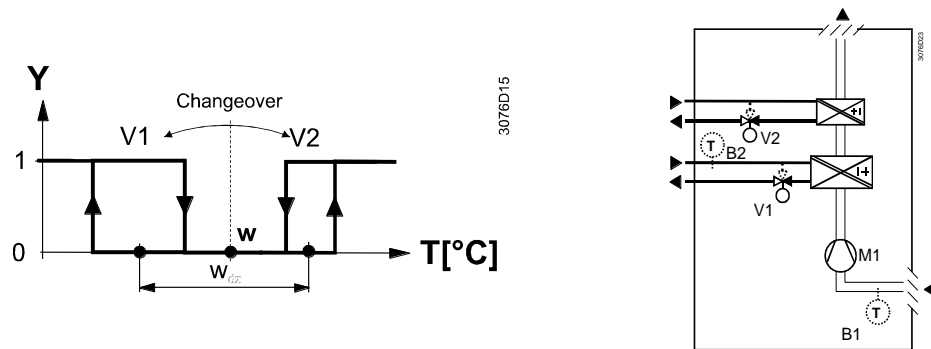

Control sequence on/off output

The diagram below shows the control sequence for on/off (2-position) control.

Heating and cooling mode (P01 = 4 or 3)

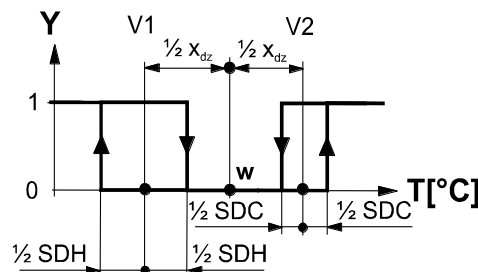

T[°C] Room temperature

w Room temperature setpoint

V1 Control. command “Valve” or “Comp.” Heat

V2 Control. command “Valve” or “Comp.” Cool

SDH Switching differential “Heating”

SDC Switching differential “Cooling”

X<sub>dz</sub> Dead zone

Heating mode with manual selection (P01=2)

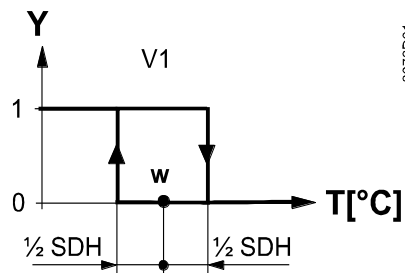

Cooling mode with manual selection (P1=2)

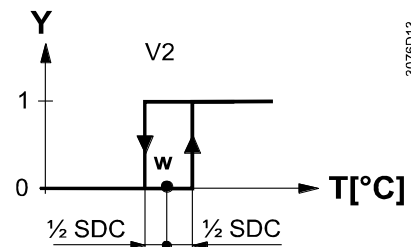

Control sequence  
modulating output

The diagram below shows the control sequence of a continuous PI control.

Heating and cooling mode (P01 = 4 or 3)

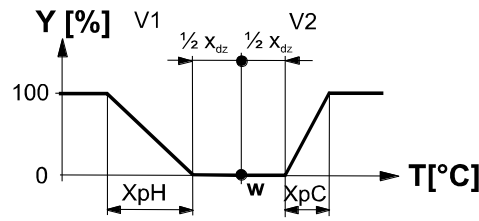

- 3076D12
- T[°C] Room temperature
  - w Room temperature setpoint
  - V1 Control command "Valve" Heating
  - V2 Control command "Valve" Cooling
  - XpH Proportional band "Heating"
  - XpC Proportional band "Cooling"
  - Xdz Dead zone

Heating mode with manual selection  
(P01=2)

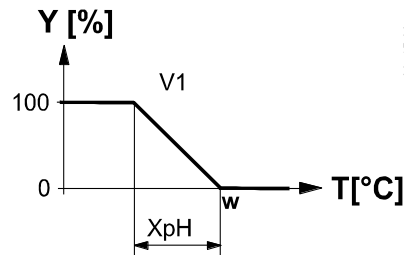

3076D03

Cooling mode with manual selection  
(P1=2)

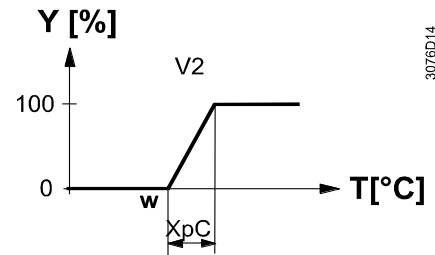

3076D14

This function (4-pipe modulating) is only available with RDF340 (2 analog outputs DC 0...10 V are required).

- Notes:
- The diagrams only show the PI thermostat's proportional part.
  - For the fan sequence see section 4.8.

## 4.7 Control outputs

### Overview of control outputs

Different control output signals are available depending on the controller type.

Control output	on/off	3-position	DC 0...10 V
Type reference			
RDF300...	Y11, Y21 (2)	Y11/Y21 (1)	
RDF400...	Y11, Y21 (2)	Y11/Y21 (1)	
RDF340...			Y10, Y20 (2)
RDF600	Y11, Y21 (2)	Y11/Y21 (1)	
RDF600T	Y11, Y21 (2)	Y11/Y21 (1)	

( ) Number of outputs

### on/off control signal (2-position)

The valve or compressor receives the **OPEN/ON** command via control output Y11 or Y21:

1. When the acquired room temperature is below the setpoint (heating mode) or above the setpoint (cooling mode).
2. When control outputs Y11/Y21 were not energized for more than the "Minimum output off time" (factory setting 1 minute, adjustable via parameter P48).

The valve or compressor receives the **CLOSE/OFF** command via control output Y11 or Y21:

1. When the acquired room temperature is above the setpoint (heating mode) or below the setpoint (cooling mode).
2. When control outputs Y11/Y21 were energized for more than the "Minimum output on time"; (factory setting 1 minute, adjustable via parameter P49).

### 3-position control signal

Output Y11 provides the **OPEN** command, and Y21 the **CLOSE** command to the 3-position actuator. The factory setting for the runtime is 150 seconds (adjustable via parameter P44 from 50...240 seconds).

1. When the controller gets powered up, a closing command for the actuator runtime + 150% is provided to ensure that the actuator fully closes and synchronizes to the control algorithm. (RDF3..., 4...: SW < 3.1: + 20%).
2. When the controller calculates the positions fully close or fully open, the actuator runtime is extended + 150% to ensure the right actuator position synchronized to the control algorithm. (RDF3..., 4...: SW < 3.1: + 20%).
3. After the actuator reaches the position calculated by the controller, a waiting time of 30 seconds is applied to stabilize the outputs.

### Electrical heater control signal (2-position)

The electrical heater receives an **ON** command via the auxiliary heating control output Y21:

1. When the acquired room temperature is below "setpoint for electrical heater".
2. When the electrical heater has been switched off for more than 1 minute.

The **OFF** command for the electrical heater is output:

1. When the acquired room temperature is above the setpoint (electrical heater).
2. When the electrical heater has been switched on for more than 1 minute.

### Caution!

A safety thermostat (to prevent overheating) must be provided externally.

### DC 0...10 V control signal

The demand calculated by PI control from the current room temperature and setpoint is provided via Y10 and Y20 to the valve actuator as a continuous DC 0...10 V signal.



## 4.8 Fan control

The fan operates in automatic mode or at the selected speed with manual mode. In automatic mode, the fan speed depends on the setpoint and the current room temperature. When the room temperature reaches the setpoint, the control valve closes and the fan switches off or stays at fan speed 1 (parameter P60)

Factory setting for P60:

- RDF600... fan Off in dead zone
- RDF3..., RDF4... fan speed1 in dead zone

The individual switching points for **ON** of each fan stage can be adjusted via control parameters P55 – P57. The fan speed switch-off point is 20% below the switch-on point. The diagram below shows fan speed control for continuous PI control.

Fan control with modulating control

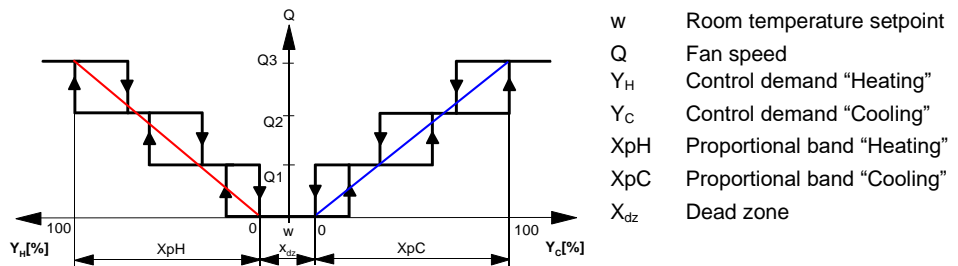

Note: The diagram only shows the PI controller's proportional part.

Fan control with on/off control

In applications with on/off control (2-position):

- 1) The switching point for low fan speed (Q1) is synchronized to the heating/cooling output. Parameter "Switching point fan speed low" P57 is not relevant.
- 2) The maximal switching range of the fan ( $X_{pH_{Fan}}/X_{pC_{Fan}}$ ) is defined by the switching differential (SDH/SDC) via a look-up table.

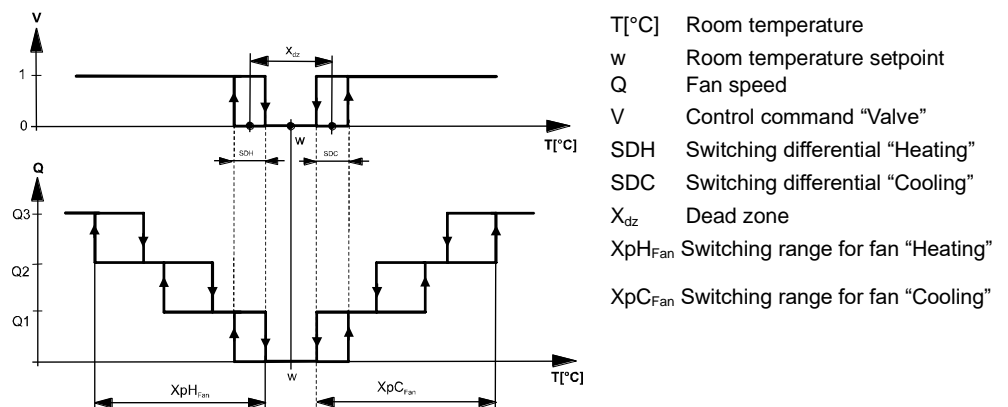

Look-up table with on/off control

SDH/SDC [K]	0.5	1.0	1.5	2.0	2.5	3.0	3.5	4.0	>4.5
$X_{pH_{Fan}}/X_{pC_{Fan}}$ [K]	2	3	4	5	6	7	8	9	10

### 3-speed/1-speed fan

The fan speed controller can control a 3-speed or single-speed fan (selected via control parameter P53). A single-speed fan is connected to terminal Q1, a 3-speed fan to terminals Q1, Q2 and Q3.

**Fan operation as per heating/cooling mode, or disabled**

Fan operation can be limited to be active only in cooling or heating mode, or even totally disabled via control parameter "Fan operation" P52. When fan operation is disabled, the fan symbol on the display disappears and actuating the fan button has no influence. This function allows for using the controller in universal applications such as floor heating with fan coil cooling etc.

**Fan minimum on-time**

In automatic mode, a dwelling time of 2 minutes (factory setting) is active. The fan maintains each speed for at least 2 minutes before it changes to the next speed. This minimum on-time can be adjusted from 1...5 minutes via parameter P59.

**Fan operation in dead zone**

In automatic fan mode and with the room temperature in the dead zone, the control valve normally is closed and the fan is disabled. With the fan kick function, the fan can be released from time to time at low speed for minimum on-time (see above) even if the valve is closed.

This function can be used to avoid damage from moisture due to a lack of air circulation, or to allow a return air sensor to measure the correct room temperature.

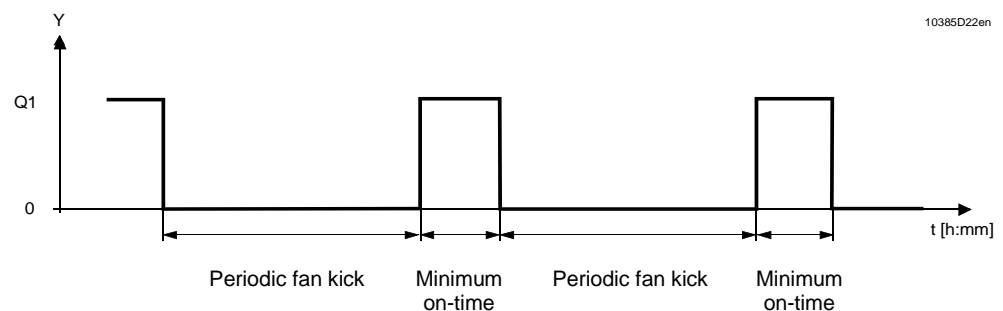

The periodic fan kick time can be selected individually for Comfort mode via parameter P60 and for Economy mode via parameter P61.

Note: Fan kick value "0" means the fan runs continuously in the dead zone.  
Fan kick value "OFF" means the fan is not running in the dead zone.

**Fan start**

When the fan starts from standstill, it starts at speed 3 for 1 second to guarantee safe fan motor start by overcoming inertia and friction (selected via parameter P58).

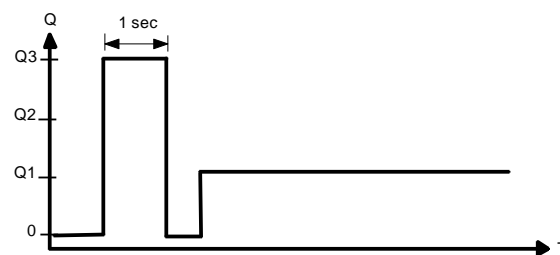

**Fan overrun for electrical heater**

When the electrical heater is switched off, the fan overruns for 60 seconds (parameter P54) to avoid overtemperatures of the electrical heater or prevent thermal cutout from responding.

 Fan failure

In case of fan failure, the controller cannot protect the electrical heater against overtemperatures. That is why the electrical heater must feature a separate safety device (thermal cutout).

**Clean fan filter reminder**

The clean fan filter reminder function counts the fan operating hours and displays message “FIL”  to remind the user to clean the fan filter as soon as the threshold is reached. This does not impact controller operations, which continues to run normally.

The service interval can be set via parameter P62.

The clean filter reminder is reset when the operating mode is manually set to Protection respectively .

**Fan in Auto Timer mode**  
(RDF400... only)

In Auto Timer mode, default fan mode is automatic. The fan mode can be changed to manual by pushing the “FAN” button. The fan returns to the automatic default mode after each switchover from Comfort to Economy and vice-versa.

## 4.9 Multifunctional input

The controller offers two multifunctional inputs X1 and X2. A sensor of type NTC like QAH11.1 (AI) or a switch (DI) can be connected to the input terminals. The functionality of both inputs can be configured via parameters P38 for input X1 and P40 for input X2.

#	Function of input X1/X2	Description	Type
0	Not used	No function.	-
1	External/Return air temp.	Sensor input for external room temperature sensor or return air temperature sensor to measure the current room temperature, or floor heating temperature sensor to limit the heating output. <i>Note:</i> The room temperature is measured by the built-in sensor if the floor heating limitation function is enabled via parameter P51.	AI
2	Heat/cool changeover	Sensor input for automatic heating / cooling changeover function. A switch can also be connected rather than a sensor (switch closed = cooling, see section 4.5).	AI/(DI)
3	Operating mode switchover	Digital input to switch over the operating mode to Economy. If the operating mode switchover contact is active, user operations are ineffective and "OFF" is displayed.	DI
4	Dewpoint monitor	Digital input for a dewpoint sensor to detect condensation. Cooling is stopped if condensation occurs.	DI
5	Enable electrical heater	Digital input to enable/disable the electrical heater via remote control.	DI
6	Alarm	Digital input to signal an alarm. If the input is active, "ALx" (x:=1 or 2) is displayed. <i>Note:</i> Alarm displays do not influence controller operations. They merely represent a visual signal. <i>Example:</i> dirty air filter	DI

Operational action can be changed between normally open (N.O.) and normally closed (N.C.) via parameter P39 or P41 if it is a digital input (DI). Each function can only be assigned to input X1 or X2; only "Alarm" can be assigned to both inputs.

X1 is factory-set to "Operating mode switchover" (3) and X2 to "Heating/cooling changeover" (2).

For more information see section 4.4 "Applications".

## 4.10 Auto Timer (RDF400... / RDF600T only)

The controller provides an Auto Timer mode with 8 programmable timers. Each timer can be assigned to one or several days. In this mode, the controller automatically changes over between Comfort and Economy mode as per the preprogrammed timers.

Auto Timer for Comfort mode



Auto Timer for Economy mode



### Set timers



Each timer has a Comfort mode start and end time that can be applied to one or several weekdays.

To adjust the time schedule, press the  button for 3 seconds to go to the programmable timer setting mode.

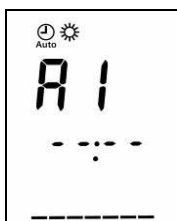

This mode is indicated by Ax (x= auto timer 1...8) and the time -- : -- flashes.



Proceed as follows for each Auto Timer:

1. The  and  symbols are displayed. Press + or - to adjust the Comfort mode start time and confirm by pressing .



2. The  and  symbols are displayed. Press + or - to adjust the Comfort mode end time or Economy start time and confirm by pressing .



3. Symbol **1** flashes. Press + or - to select or clear each day and go to the next day. Confirm the actual timer settings by pressing ✓ and go to the next timer.



The controller closes the programmable timer setting mode if no button is pressed within 20 seconds. All changes made after pressing the ✓ button for the last time are lost.

### View timers

Press the  button to review the 8 timers in sequence.

### Default timer setting



Timers A1...A4 have the following default settings (residential use):

Day/s	Time when controller is in Comfort mode *	
Mo (1) – Fr (5)	06:30 – 08:30 (A1)	17:30 – 22:30 (A2)
Sa (6)	08:00 – 23:00 (A3)	
Su (7)	08:00 – 22:30 (A4)	
	- For the remainder, the controller is in Economy mode C. - Timers A5...A8 are open, no default setting.	

### Reload default timer setting

The setting of these timers can be changed to individual needs.

The default setting can be reloaded any time:

1. Set the controller to Protection .
2. Press + and - simultaneously for 3 seconds. Release and press  twice within 2 seconds.

Then, the display will show “8888” during the reloading process.

### Overlapping of timer sequences

When several timer sequences overlap, the resulting output is the OR combination of the normal operating mode time of all timers.

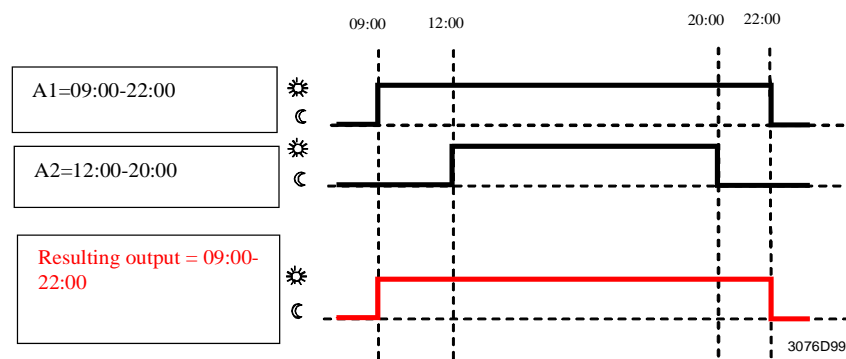

<b>7-day time clock</b>	The 7-day time clock supports 12 hour and 24 hour format. Select the format while setting the time clock as follows:
Set the time clock	<ol style="list-style-type: none"> <li>1. Press the <math>\ominus</math> button until the time digits start to flash and then press + or - to set the time of day. If the current time is in the 24-hour format and you want to change to 12-hour format, press + passing 23:59 or press - passing 00:00 and vice-versa to return to 24-hour format.</li> <li>2. Confirm the time of day by pressing <math>\surd</math> and the weekday indicator starts to flash.</li> <li>3. Press + or - to set the current weekday.</li> <li>4. Confirm the current weekday by pressing <math>\surd</math>.</li> </ol>
Power failure	In the event of a power failure, the clock stops, but its last time is stored. This time information is reloaded and starts running after power up. The clock flashes to indicate that there was a power failure until the time is confirmed by pressing $\surd$ , or readjusted by following the above procedure.

## 4.11 Error handling

---

<b>Temperature out of range</b>	<p>When the room temperature is outside the measuring range, i.e. above 49 °C or below 0 °C, the limiting temperatures flash, e.g. "0 °C" or "49 °C".</p> <p>Output Y11 is energized if the current setpoint is not set to "OFF", the controller is in heating mode and the temperature is below 0 °C. For all other cases, output Y11 is de-energized. The controller resumes Comfort mode after the temperature returns to within the measuring range.</p>
<b>Power failure</b>	<p>In the event of a power failure, all working conditions (operating mode, setpoint, fan stage, all control parameter settings) are stored without time limitation.</p> <p>When power returns, the thermostat reloads this data and continues to work in the same conditions as before.</p> <p>For thermostats with auto timer refer to section 4.10.</p>

## 4.12 Infrared remote control

---

Use the IRA211 infrared remote control to operate a controller with built-in infrared receiver. The following operations can be carried out remotely:

- Select operating modes Protection, Comfort or Auto Timer.
- Adjust setpoint in Comfort mode.
- Select fan modes Automatic or Manual.

A buzzer in the thermostat indicates remote control command reception. Infrared remote control can be disabled via parameter P70.

## 4.13 DIP switches



Use the DIP switches on the inner side of the front panel to commission the basic controller applications prior to snapping it to the base.

RDF300... / RDF400... / RDF600... have the following DIP switch settings:

RDF300... / RDF400... /  
RDF600...

DIP switch number	1	2
<i>Application</i>		
2-pipe	OFF	OFF
2-pipe, 3 position	ON	OFF
2-pipe & electrical heater	OFF	ON
4-pipe <sup>1)</sup>	ON	ON

RDF340 has the following DIP switch settings:

RDF340

DIP switch number	1	2
<i>Application</i>		
2-pipe	OFF	OFF
2-pipe & electrical heater	OFF	ON
4-pipe <sup>1)</sup>	ON	ON

1) Factory setting

Note: During startup, the controller reloads the control parameter factory settings after each DIP switch settings change.

## 4.14 Control parameters

A number of control parameters can be readjusted to optimize control performance. These parameters can also be set during operation without opening the unit. In the event of a power failure, all control parameter settings are retained.

The control parameters are divided in two levels:

- “Service” level, and
- “Expert” level, including Diagnostic and Test

The “Service” level contains a small set of parameters to set up the controller for the HVAC system and to adjust the user interface. These parameters can usually be adjusted any time.

Change parameters in the “Expert” level only carefully, as they impact control performance and functionality of the controller.

### Parameter setting

Enter only “Service” level

Change the parameters as follows:

1. Set the controller to Protection  $\cup$  \*)
2. Press buttons + and - simultaneously for 4 seconds.  
Release and press button + again within 2 seconds until the display shows “P01”.  
Continue at Step 3.

Enter “Service” and “Expert” level.

1. Set the controller to Protection  $\cup$  \*)
2. Press buttons + and – simultaneously for 4 seconds.  
Release and press button – again within 2 seconds until the display shows “P01”.



## Adjust parameters

3. Select the required parameter by repeatedly pressing buttons + and -.
4. When you press buttons + and - simultaneously, the current value of the selected parameter starts to flash, which can be changed by repeatedly pressing buttons + or -.
5. When you again press buttons + and - simultaneously, the next parameter is displayed.
6. Repeat Steps 3 to 5 to display and change additional parameters.
7. All changes are saved and the controller returns to Protection 10 seconds after the last display or setting.

## Reset parameters

The factory settings for the control parameters can be reloaded via parameter P71, by changing the value to "ON", and confirming by pressing buttons + and - simultaneously. The display shows "8888" during reload.

### Note! \*)

- RDF400... and RDF600T: Step 1 is not required.
- RDF3... and RDF600: Step 1 is required.

If one of the digital inputs is commissioned as window contact, and the contact is closed, the controller will be switched to ECO mode and parameter setting will not be possible. Solution: open the window contact.

## Control parameters

#	Parameter	Factory setting	Setting range	RDF300... RDF600	RDF340... RDF600T	RDF400... RDF600T
<b>Service Level</b>						
P01	Control sequence	2-pipe: [0..3] 1 (Cool only)  4-pipe: [2...4] 4 (Heat&Cool)	0:= Heating only 1:= Cooling only 2:= Manual H/C 3:= Auto changeover 4:= Heating & cooling	✓	✓	✓
P02	Mode selection via user operating mode button	1 (Stb, Comf)	1 = Stb, Comf 2 = Stb, Comf, Eco	✓	✓	✓
P04	Selection of °C or °F	°C (0)	(0) °C or (1) °F	✓	✓	✓
P05	Sensor calibration	0.0 K	- 3 ... +3 K	✓	✓	✓
P06	Standard temperature display	0 (Room temp)	0:= Room temperature 1:= Setpoint	✓	✓	✓
P07	Additional user info	0 (no display)	0:= no display 1:= Temp in °C and °F	✓	✓	✗
P08	Comfort basic setpoint	21 °C	5 ... 40 °C	✓	✓	✓
P09	Minimum setpoint limitation for Comfort (WminComf)	5 °C	5 ... 40 °C	✓	✓	✓
P10	Maximum setpoint limitation for Comfort (WmaxComf)	35 °C	5 ... 40 °C	✓	✓	✓
P11	Heating setpoint for Economy (WheatEco)	15 °C	OFF, 5 °C...WcoolEco	✓	✓	✓
P12	Cooling setpoint for Economy (WcoolEco)	30 °C	OFF, WheatEco...40 °C	✓	✓	✓
P13	Electrical reheater for cooling mode	ON	ON:= enabled OFF:= disabled	✓	✓	✓
P14	Key lock (Press the operating mode button  for 7 seconds to enable or disable the key lock) RDF600... : 3 seconds	0 (Unlocked)	0:= Unlocked 1:= Auto lock 2:= Manual lock	✓	✓	✓

### Note

- P02 is not available when the controller is commissioned for manual heating/cooling changeover P01=2
- Parameter display depends on selected application and function

(x) Not available

#	Parameter	Factory setting	Setting range	RDF300... RDF600	RDF340...	RDF400... RDF600T
<b>Expert Level</b>						
P30	P-band/Switching differential for heating mode	2K	0.5 ... 6 K	✓	✓	✓
P31	P-band/Switching differential for cooling mode	1 K	0.5 ... 6 K	✓	✓	✓
P33	Dead zone in Comfort mode	2 K	0.5 ... 5 K	✓	✓	✓
P34	Setpoint differential	2 K	0.5 ... 5 K	✓	✓	✓
P35	Integral time	5 min	0...10 min	✓	✓	✓
P36	Heating/cooling changeover switching point for cooling	16 °C	10...25 °C	✓	✓	✓
P37	Heating/cooling changeover switching point for heating	28 °C	27...40 °C	✓	✓	✓
P38	X1 functionality	3 (Op mode switchover)	0:= NA 1:= Ext/Return air temp 2:= Heat/cool changeover 3:= Operating mode switch 4:= Dewpoint monitor 5:= Enable electrical heater 6:= Alarm input	✓	✓	✓
P39	Operating action for X1 if digital input	0 (N.O.)	0:= Normally open 1:= Normally closed	✓	✓	✓
P40	X2 functionality	2 (H/C c/o)	Same as P38	✓	✓	✓
P41	Operating action for X2 if digital input	0 (N.O.)	0:= Normally open 1:= Normally closed	✓	✓	✓
P44	Runtime for 3-position output (Y11/Y21)	150 s	50...240 sec	✓	✗	✓
P48	Minimum output on-time via on/off control output	1 min.	1...20 minutes	✓	✗	✓
P49	Minimum output off-time via on/off control output	1 min.	1...20 minutes	✓	✗	✓
P50	Purge function (minimum every 2 hours)	OFF	OFF: Inactive 1...5 min	✓	✓	✓
P51	Floor heating limit temperature	OFF	OFF, 10..50 °C	✓	✗	✓
P52	Fan operation	1 (Enabled)	0:= Disabled 1:= Enabled 2:= Only in heating 3:= Only in cooling	✓	✓	✓
P53	Fan speed	2 (3-speed)	1:= 1-speed 2:= 3-speed	✓	✓	✓
P54	Fan overrun time (only when electrical heater is used)	60 sec	0 ... 300 sec	✓	✓	✓
P55	Switching point fan speed high	100%	80..100%	✓	✓	✓
P56	Switching point fan speed med	65%	30..75%	✓	✓	✓
P57	Switching point fan speed low	10%	1..15%%	✓	✓	✓
P58	Fan start kick	ON	ON: enabled OFF: disabled	✓	✓	✓
P59	Fan minimum on-time	2 min	1 ... 5 min	✓	✓	✓
P60	Fan kick in Comfort mode (time to next kick)	0 (continuous) Off	0...89min, OFF	✓	✓	✓
P61	Fan kick in Economy mode (time to next kick)	OFF	0...359min, OFF	✓	✓	✓
P62	Clean filter reminder runtime	OFF	OFF, 100 ... 9900 hours	✓	✓	✓
P65	Heating setpoint for Protection $\cup$ (Wheat <sub>Stb</sub> )	8 °C	OFF, 5 °C...Wcool <sub>Stb</sub>	✓	✓	✓
P66	Cooling setpoint for Protection $\cup$ (Wcool <sub>Stb</sub> )	OFF	OFF, Wheat <sub>Stb</sub> ...40 °C	✓	✓	✓
P69	Temporary setpoint for Comfort mode	OFF	OFF:= Disabled ON := Enable	✓	✓	✓
P70	Infrared receiver	OFF	OFF:= Disabled ON := Enable	✗	✗	✓
P71	Parameter reset Set value to ON and confirm by pressing the + and - buttons	OFF	OFF:= Idle ON: = Reset	✓	✓	✓
<b>Diagnostic &amp; Test</b>						
d01	Application	Diagnose	2P:= 2-pipe 2PEL:= 2-pipe & el. heater 4P:= 4-pipe 2P3P:= 2-pipe 3pos	✓	✓	✓
d02	Status input X1	Diagnose	0:= Digital input not activated 1:= Digital input activated 0...49 °C = measured temp. value 00 := H/C input short 100:= H/C input open	✓	✓	✓
d03	Status input X2	Diagnose	Same as d02	✓	✓	✓
d05	Test mode to check the 3-position Y11/Y21 actuator direction. Note that this parameter can be quit only if the setting is back at "--" and by pressing + and - buttons	Diagnose	"--" := no signal OPE:= Y11 active →open CLO:= Y21 active→close	✓	✗	✓

# 5 Handling

## 5.1 Mounting and installation

Mount the room controller on the conduit box. Do not mount on a wall in niches or bookshelves, behind curtains, above or near heat sources, or exposed to direct solar radiation. Mount about 1.5 m above the floor.

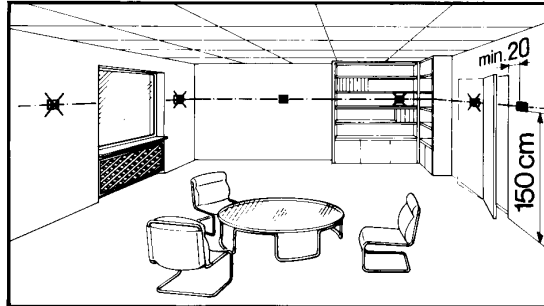

### Mounting / dismounting



- Devices must be mounted on clean, dry indoor place without direct airflow from a heating / cooling device, and not be exposed to dripping or splashing.
- RDF3... / RDF400...: In case of limited space in the conduit box use the mounting bracket ARG70.3 to increase the headroom by 10mm.
- Before removing the front cover, disconnect the power supply.

### Wiring



See the mounting instructions enclosed with the thermostat:  
M3076... for RDF3..., RDF4...; M3063 for RDF600...

- Wiring, protection and earthing must be installed in compliance with local regulations.
- Properly size the cables to the controller, fan and valve actuators for AC 230 V mains voltage
- Use only valve actuators rated for AC 230 V on RDF300... / RDF400... / RDF600...
- The AC 230 V mains supply line must have an external fuse or circuit breaker with a rated current of no more than 10 A
- Isolate the cables of SELV inputs X1-M/X2-M if the conduit box carries AC 230 V mains voltage
- Inputs X1-M or X2-M of different units (e.g. summer/winter switch) may be connected in parallel with an external switch. Consider overall maximum contact sensing current for switch rating



### Warning!

#### No internal line protection for supply lines to external consumers (Q1, Q2, Q3, Yxx)

Risk of fire and injury due to short-circuits!

- Adapt the line diameters as per local regulations to the rated value of the installed overcurrent protection device.
- No metal conduits
- No cables provided with a metal sheath
- Disconnect from supply before opening the cover

### Commissioning

Set the controller application via the DIP switches before snapping the front panel on the mounting base.

After power is applied, the controller carries out a reset during which all LCD segments flash indicating that the reset was correct. After the reset, which takes about 3 seconds, the controller is ready for commissioning by qualified HVAC staff.

The control parameters of the controller can be set to ensure optimum performance of the entire system (see “Set control parameters”).

Control sequence

Compressor-based application 

Calibrate sensor

Setpoint and range limitation

- The control sequence may need to be set via parameter P01 depending on the application. The factory setting for the 2-pipe application is “Cooling only”; and “Heating and Cooling” for the 4-pipe application
- When the controller is used with a compressor, the minimum output on-time (parameter P48) and off-time (parameter P49) for Y11/Y21 must be adjusted to avoid damaging the compressor and shortening its life
- Recalibrate the temperature sensor if the room temperature displayed on the controller does not match the room temperature measured. To do this, change parameter P05
- We recommend to review the setpoints and setpoint ranges (parameters P08...P12) and change them as needed to achieve maximum comfort and save energy

## 5.2 Operating Instructions

---

See the operating instructions B3076... enclosed with the controller.

## 5.3 Disposal

---



This symbol or any other national label indicate that the product, its packaging, and, where applicable, any batteries may not be disposed of as domestic waste. Delete all personal data and dispose of the item(s) at separate collection and recycling facilities in accordance with local and national legislation. For additional details, refer to [Siemens information on disposal](#).

# 6 Engineering

## 6.1 Connection terminals

RDF300... / RDF400... /  
RDF600....

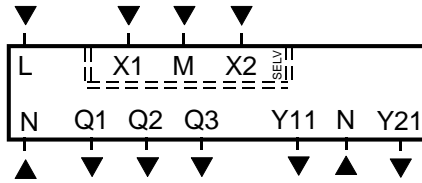

- L, N Operating voltage AC 230 V
- Q1 Control output "Fan speed 1 AC 230 V"
- Q2 Control output "Fan speed 2 AC 230 V"
- Q3 Control output "Fan speed 3 AC 230 V"
- Y11, Y21 Control output "Valve" AC 230 V (N.O., for normally closed valves), output for compressor or output for electrical heater
- X1, X2 Multifunctional input for temperature sensor (e.g. QAH11.1) or potential-free switch
- M Measuring neutral for sensor and switch

RDF340...

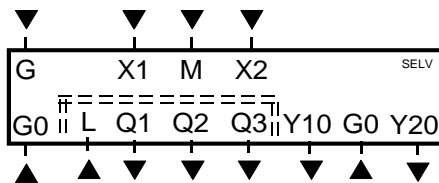

- G, G0 Operating voltage controller AC 24 V
- L Operating voltage for fan AC 230 V
- Q1 Control output "Fan speed 1 AC 230 V"
- Q2 Control output "Fan speed 2 AC 230 V"
- Q3 Control output "Fan speed 3 AC 230 V"
- Y10, Y20 Control output for 0...10 V actuator
- X1, X2 Multifunctional input for temperature sensor (e.g. QAH11.1) or switch
- M Measuring neutral for sensor and switch

## 6.2 Connection diagrams

### 6.2.1 Water-based fan coil applications with RDF300... / RDF400... / RDF600...

Application:

#### 2-pipe fan coil units

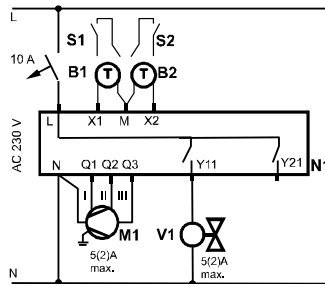

- M1 3-speed fan
- N1 Room thermostat  
RDF300... / RDF400... / RDF600...
- V1 Zone valve
- S1, S2 Switch (keycard, window contact, etc.)
- B1, B2 Temperature sensor (return air temperature, external room temperature, changeover sensor, etc.)

Application:

#### 2-pipe fan coil units with electrical heater

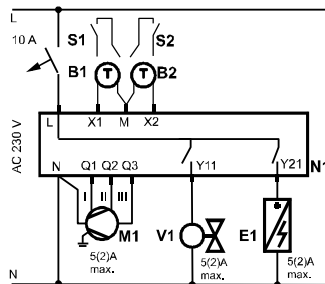

- M1 3-speed fan
- N1 Room thermostat  
RDF300... / RDF400... / RDF600...
- V1 Zone valve
- E1 Electrical heater
- S1, S2 Switch (keycard, window contact, etc.)
- B1, B2 Temperature sensor (return air temperature, external room temperature, changeover sensor, etc.)

Application:

#### 4-pipe fan coil units

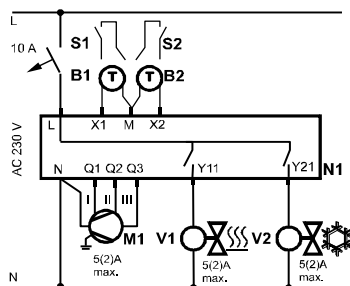

- M1 3-speed fan
- N1 Room thermostat  
RDF300... / RDF400... / RDF600...
- V1 Zone valve "Heating"
- V2 Zone valve "Cooling"
- S1, S2 Switch (keycard, window contact, etc.)
- B1, B2 Temperature sensor (return air temperature, external room temperature, changeover sensor, etc.)

Application:

#### 2-pipe fan coil units, 3-position

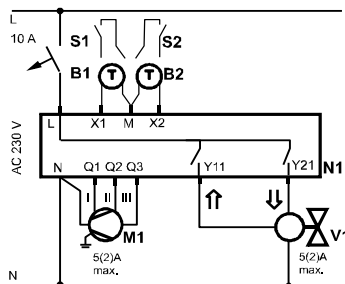

- M1 3-speed fan
- N1 Room thermostat  
RDF300... / RDF400... / RDF600...
- V1 Zone valve, 3-position
- S1, S2 Switch (keycard, window contact, etc.)
- B1, B2 Temperature sensor (return air temperature, external room temperature, changeover sensor, etc.)

Application:

#### 2-pipe fan coil units with single-speed fan

Note: Single-speed fan possible also in other applications!

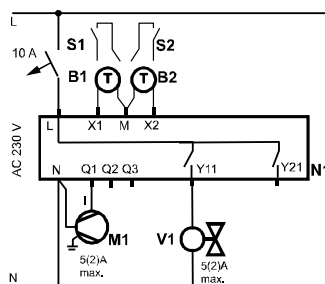

- M1 Single-speed fan
- N1 Room thermostat  
RDF300... / RDF400... / RDF600...
- V1 Zone valve
- S1, S2 Switch (keycard, window contact, etc.)
- B1, B2 Temperature sensor (return air temperature, external room temperature, changeover sensor, etc.)

## 6.2.2 Compressor-based applications with RDF300... / RDF400... / RDF600...

Application:

### Compressor in DX-type equipment

(DIP setting: "2-pipe")

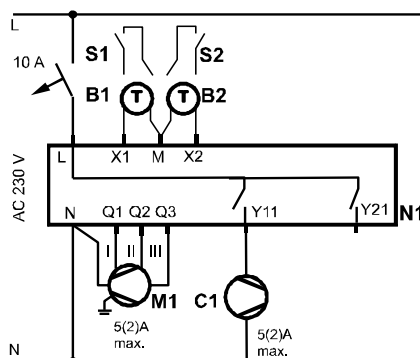

- M1 3-speed fan
- N1 Room thermostat  
RDF300... / RDF400... / RDF600...
- C1 Compressor
- S1, S2 Switch (keycard, window contact, etc.)
- B1, B2 Temperature sensor (return air temperature, external room temperature sensor, etc.)

Application:

### Compressor in DX-type equipment with electrical heater

(DIP setting: "2-pipe & el. heater")

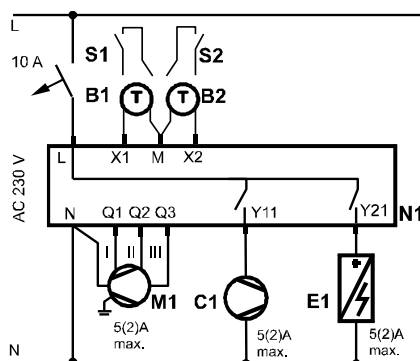

- M1 3-speed fan
- N1 Room thermostat  
RDF300... / RDF400... / RDF600...
- C1 Compressor
- E1 Electrical heater
- S1, S2 Switch (keycard, window contact, etc.)
- B1, B2 Temperature sensor (return air temperature, external room temperature sensor, etc.)

Application:

### Compressor in DX-type equipment heating and cooling

(DIP setting: "4-pipe")

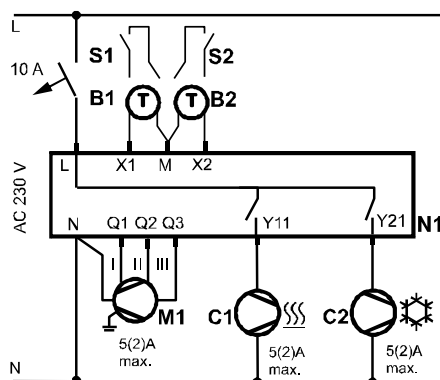

- M1 3-speed fan
- N1 Room thermostat  
RDF300... / RDF400... / RDF600...
- C1 Compressor "Heating"
- C2 Compressor "Cooling"
- S1, S2 Switch (keycard, window contact, etc.)
- B1, B2 Temperature sensor (return air temperature, external room temperature sensor, etc.)

Note:

Use an external relay for designated reversing valve and compressor equipment terminal connections. See DX equipment wiring diagram for connection details.

## 6.2.3 Water-based fan coil applications with RDF340...

Application:

### 2-pipe fan coil units

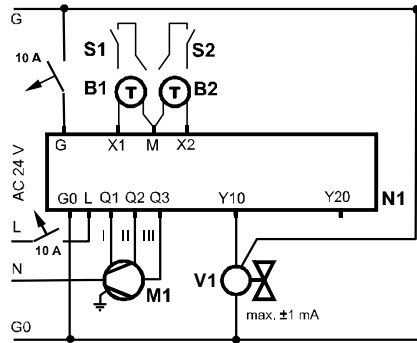

- M1 3-speed fan
- N1 Room thermostat RDF340...
- V1 Zone valve
- S1, S2 Switch (keycard, window contact, etc.)
- B1, B2 Temperature sensor (return air temperature, external room temperature, changeover sensor, etc.)

Application:

### 2-pipe fan coil units with electrical heater

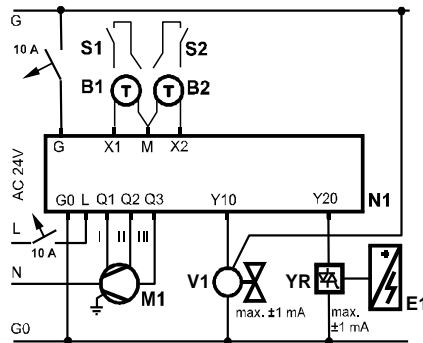

- M1 3-speed fan
- N1 Room thermostat RDF340...
- V1 Zone valve
- YR 0...10 signal converter/current valve
- E1 Electrical heater
- S1, S2 Switch (keycard, window contact, etc.)
- B1, B2 Temperature sensor (return air temperature, external room temperature, changeover sensor, etc.)

Application:

### 4-pipe fan coil units

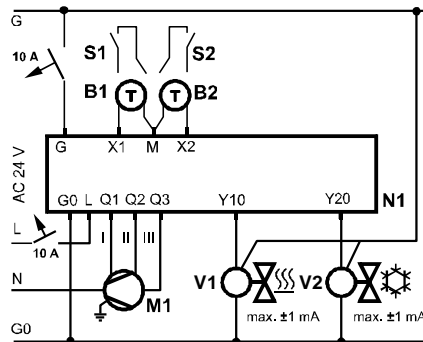

- M1 3-speed fan
- N1 Room thermostat RDF340...
- V1 Zone valve "Heating"
- V2 Zone valve "Cooling"
- S1, S2 Switch (keycard, window contact, etc.)
- B1, B2 Temperature sensor (return air temperature, external room temperature, changeover sensor, etc.)

Application:

### 4-pipe fan coil units with single-speed fan

Note: Single-speed fan also possible in other applications!

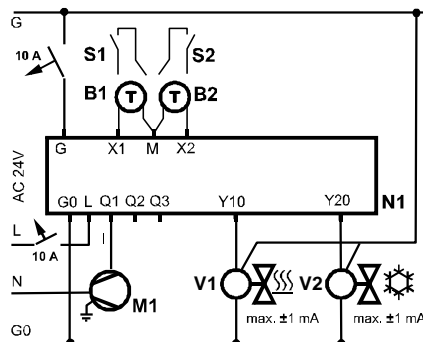

- M1 3-speed fan
- N1 Room thermostat RDF340...
- V1 Zone valve "Heating"
- V2 Zone valve "Cooling"
- S1, S2 Switch (keycard, window contact, etc.)
- B1, B2 Temperature sensor (return air temperature, external room temperature, changeover sensor, etc.)



Warning

For US installations use Class 2 rated power supplies.

For other installations use circuit breakers with rated current of no more than 10 A.



# 7 Mechanical design

The controller consists of 2 parts:

- Front panel accommodating the electronics, operating elements and built-in room temperature sensor.
- Mounting base with the power electronics.

The rear of the mounting base contains the screw terminals.

Slide the front panel in the mounting base and snap on.

## Operation and settings RDF300... / RDF340... / RDF600

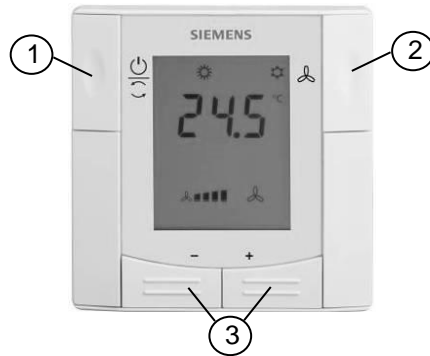

1. Operating mode selector / Protection
2. Change fan operation
3. Adjust setpoint and control parameters

## RDF400... / RDF600T

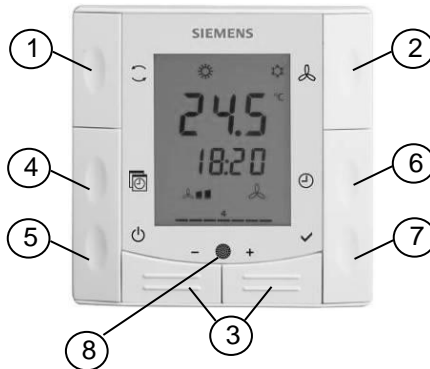

1. Change operating mode selector
2. Change fan operation
3. Adjust setpoint, control parameters and time of day
4. Auto Timer program
5. Protection
6. Set time of day and weekday
7. Confirm
8. Infrared receiver

## Display

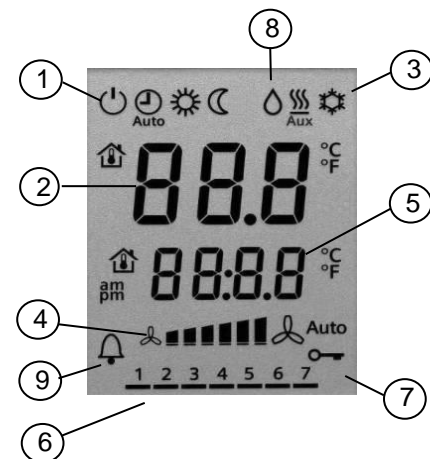

1. Operating mode  
 Protection mode  
 Auto Timer mode\*  
 Comfort mode  
 Economy mode

\* only on RDF400... / RDF600T

2. Display room temperature, setpoints and control parameters.  
 Symbol used to display the current room temperature
3. Heating/cooling mode  
 Cooling mode  
 Heating mode,  
 Electrical heater active
4. Fan mode  
 Auto fan active  
 Fan speed low, medium, high
5. Additional user information (RDF3xx) or current time of day (RDF400... / RDF600T)
6. Weekday 1...7 (1 = Monday/7 = Sunday)\*
7. Key lock active
8. Condensation in room (dewpoint sensor active)
9. Indicate alarm or reminder

# 7.1 Dimensions

Dimensions in mm

RDF3... RDF400...

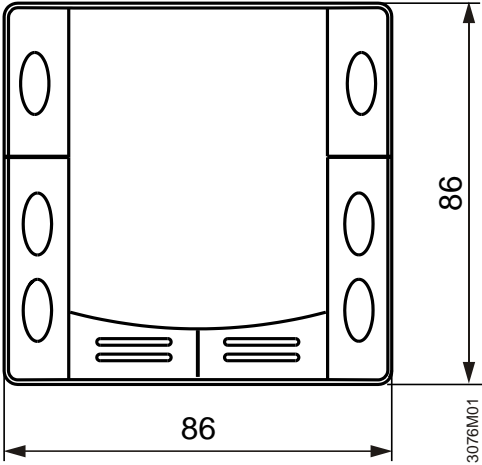

RDF600...

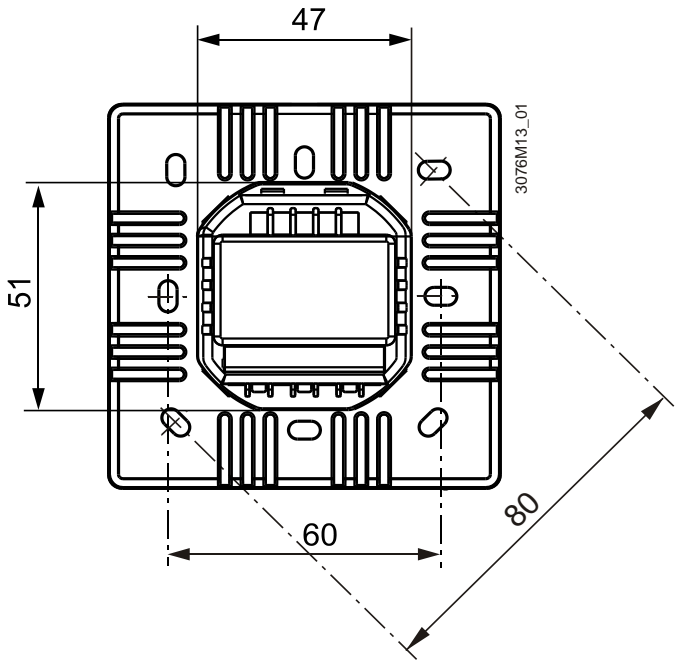
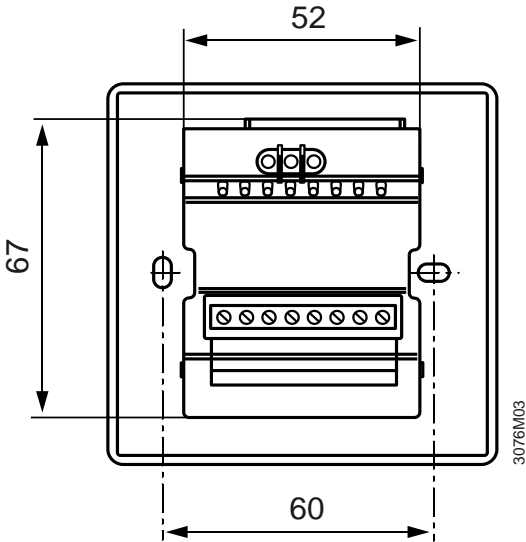
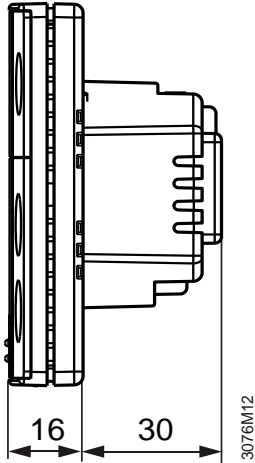
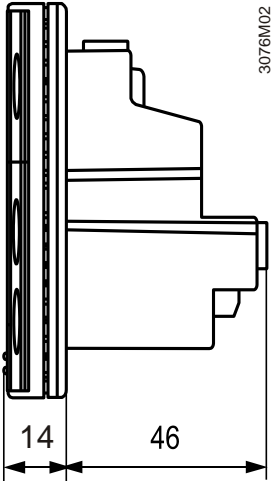
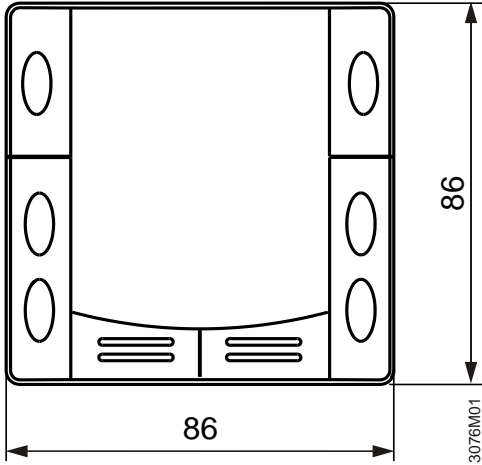

## 8 Technical data

 Power supply

Rated voltage	RDF300... /400... / 600... RDF340...	AC 230 V SELV AC 24 V $\pm$ 20 % or AC 24 V class 2 (US)
Frequency		50/60 Hz
Power consumption	RDF300... / RDF400... RDF340... RDF600...	Max. 8 VA Max. 3.5 VA / 0.8 W
External supply line protection (EU)		Circuit breaker max. 10 A Characteristic B, C, D according to EN 60898 or Power source with current limitation of max. 10 A



### No internal fuse

External preliminary protection with max. C 10 A circuit breaker in the supply line required under all circumstances

Outputs



Fan control Q1, Q2, Q3-N		AC 230 V
Rating		5 mA...5(2) A
Control output Y11-N/Y21-N (N.O.)		AC 230 V
Rating		5 mA...5(2) A
Control output Y10-G0/Y20-G0		SELV DC 0...10 V
Resolution		39 mV
Current		Max. $\pm$ 1 mA

Max. total load current through terminal "L" (Qx + Yxx) Max. 7 A

Inputs

Multifunctional input X1-M/X2-M		
Temperature sensor input:		
Type		NTC (3 k $\Omega$ at 25 °C)
Temperature range		0...49 °C
Cable length		Max. 80 m
Digital input:		
Operating action		Selectable (N.O./N.C.)
Contact sensing		SELV DC 0...5 V/max 5 mA
Parallel connection of several thermostats for one switch		Max. 20 thermostats per switch
Insulation against mains voltage (SELV)		4 kV, reinforced insulation
Function input:		
External temperature sensor, heating/cooling changeover sensor, operating mode switchover contact, dewpoint monitor contact, enable electrical heater contact, alarm contact		Selectable

Operational data

Switching differential, adjustable		
Heating mode	(P30)	2 K (0.5...6K)
Cooling mode	(P31)	1 K (0.5...6K)
Setpoint setting and range		
 Comfort mode	(P08)	21°C (5...40 °C)
 Economy mode	(P11-P12)	15°C/30°C (OFF, 5...40 °C)
 Protection	(P65-P66)	8°C/OFF (OFF, 5...40 °C)
Multifunctional input X1/X2		Selectable 0...6
Input X1		3: (P38) operating mode switchover
Input X2		2: (P40) heating/cooling changeover sensor

	Built-in room temperature sensor	
	Measuring range	0...49 °C
	Accuracy at 25 °C	< ± 0.5 K
	Temperature calibration range	± 3.0 K
Environmental conditions	Settings and display resolution	
	Setpoints	0.5 °C
	Current temperature value displayed	0.5 °C
	Operation	
	Climatic conditions	As per IEC 721-3-3
	Temperature	Class 3K5
	Humidity	0...+50 °C
		<95 % r.h.
	Transport	
	Climatic conditions	As per IEC 721-3-2
Temperature	Class 2K3	
Humidity	-25...+60 °C	
Mechanical conditions	<95 % r.h.	
	Class 2M2	
Storage		
Climatic conditions	As per IEC 721-3-1	
Temperature	Class 1K3	
Humidity	-25...+60 °C	
	<95 % r.h.	
Standards and directives	EU Conformity (CE)	RDF3... CE1T3076_1 <sup>*)</sup>
		RDF4... CE1T3076xx_2 <sup>*)</sup>
		RDF600... CE1T3076xx_3 <sup>*)</sup>
	RCM Conformity	RDF3..., RDF600... A5W90002894-A <sup>*)</sup>
		RDF600... CE1T3076en-C <sup>*)</sup>
	Protective class	II as per EN 60730-1
	Pollution class	Normal
	Housing flammability class according to UL94	V-0
	Degree of protection of housing	IP 30 to EN 60529
	Environmental compatibility	The product environmental declarations CE1E3076_1en (RDF3... <sup>*)</sup> , A5W00085839A (RDF300.02/VB) <sup>*)</sup> , CE1E3076_2en (RDF4... <sup>*)</sup> , CE1E3076_4en (RDF600... <sup>*)</sup> contain data on environmentally compatible product design and assessments (RoHS compliance, materials composition, packaging, environmental benefit, disposal).
General	Connection terminals	
		Solid wires or prepared stranded wires
		1 x 0.4...1.5 mm <sup>2</sup>
Housing front color		
	RAL 9003 white	
	RAL 9004 black	
Weight	RDF3..., RDF4...	0.220 kg
	RDF600...	0.150 kg

<sup>\*)</sup> The documents can be downloaded from <http://siemens.com/bt/download>.

# Index

---

<b>1</b>		Fan start .....	26
12 hour and 24 hour format .....	31	Floor heating limitation function .....	17
1-speed fan .....	25		
<b>3</b>		<b>H</b>	
3-position .....	24	Heat/cool changeover .....	28
		Heating and cooling mode .....	18
		Heating mode .....	18
<b>A</b>			
Alarm .....	28	<b>I</b>	
Auto Timer .....	29	Infrared receiver .....	7
Automatic heating/cooling		Integral action time .....	10
changeover .....	16, 18		
<b>B</b>		<b>K</b>	
Backlit LCD .....	7	Key lock .....	17
<b>C</b>			
Calibrate sensor .....	36	<b>M</b>	
Clean fan filter reminder .....	27	Manual changeover .....	20
Comfort mode .....	11	Manually select heating or cooling	
Commissioning .....	35	mode .....	18
Conduit box .....	7	Minimum output .....	17
Control output .....	7	Modulating output .....	19
Control parameters .....	32	Moisture .....	17
Cooling mode .....	18	Mounting and installation .....	35
		Multifunctional inputs .....	28
<b>D</b>			
DC 0...10 V control signal .....	24	<b>O</b>	
Dewpoint .....	28	On/off control output signals .....	24
Diagnostic .....	32	On/off control signal .....	24
Digital input .....	28	Operating mode button .....	11
DIP switches .....	32	Operating mode input .....	11
		Operating mode switchover .....	28
<b>E</b>		Operating voltage .....	7
Economy .....	11		
Electrical heater .....	20	<b>P</b>	
Enable/disable the electrical heater		Parameter setting .....	32
.....	20, 28	Power failure .....	31
Expert level parameters .....	32	Programmable timers .....	29
External/Return air temp. ....	28	Proportional band .....	10
External/return air temperature		Protection mode .....	11
sensor .....	16	Purge function .....	16
<b>F</b>			
Factory settings .....	32	<b>R</b>	
Fan kick function .....	26	Reload default timer setting .....	30
Fan minimum on-time .....	26	Reload factory settings .....	33
Fan operation as per heating/cooling		Remote heating/ cooling changeover	
mode, or disabled .....	26	.....	16
Fan operation in dead zone .....	26	Reset parameters .....	33
Fan overrun .....	26		
		<b>S</b>	
		Sensor input .....	28
		Service level parameters .....	32
		Set the time clock .....	31

Set timers.....	29	Time program .....	7
Setpoint and range limitation .....	36	<b>U</b>	
Setpoint limitation .....	12	Universal application .....	16
Switching differential.....	10	<b>V</b>	
<b>T</b>		View timers .....	30
Temperature out of range .....	31		
Temporary setpoint .....	12		
Test .....	32		

Issued by  
 Siemens Switzerland Ltd  
 Smart Infrastructure  
 Global Headquarters  
 Theilerstrasse 1a  
 CH-6300 Zug  
 Tel. +41 58 724 2424  
[www.siemens.com/buildingtechnologies](http://www.siemens.com/buildingtechnologies)

© Siemens 2008 – 2023  
 Technical specifications and availability subject to change without notice.