

GAMMA instabus

Solar protection actuator 4/8 x 6 A

N 543D31, N 543D51



The solar protection actuators are used to control shutters, roller shutters, awnings, sunblinds or ventilation flap drives with up to AC 230 V.

- End position detection by current sensing for automatic move time determination.
- Direct operation for efficient installation displaying the moving direction and active overrides via LED.
- Maintenance-free terminals for connecting and looping through solid, stranded and fine-stranded conductors. Every L-conductor connection feeds two channels.

Functions for configuration with ETS

- Extensive control and override functions and status messages for each channel
- On-site control of the drives
- Direct moving to element or slat positions.
- Automatic control of the drives with configurable behavior when the sun is shining (sun tracking control)
- Scene control for calling up and storing defined element positions
- Safety functions through overrides in case of wind, rain, frost, moving blocks etc.

Characteristics

The solar protection actuators are used to control shutters, roller shutters, awnings, sun-blinds or ventilation flap drives with up to AC 230 V. It is used in building automation. Device control is conducted via KNX.

Through the selection of various operating modes such as manual and automatic mode, solar protection is controlled both locally and centrally. Automatic commands from a weather station enable sunlight tracking control with shade edge tracking.

The device is a rail-mounted device in N dimension for installation in arrangements and installation on 35-mm rails as per standard IEC 60715.

The bus connection of the device uses a bus terminal block. The electronics of the device are supplied via the bus voltage (no additional supply voltage required). A neutral conductor connection is not required.

The maintenance-free terminals are for connecting solid, fine-stranded and stranded conductors with conductor cross-sections from 0.5 to 2.5 mm² to the relay output channels. Stranded and fine-stranded conductors can be plugged into the terminals without ferrules. Every L-conductor connection feeds two channels.

Solar protection actuator N 543 consists of the device (hardware) and the application program (software). Depending on its use, each relay output channel can be assigned different functions.

Functions

Factory settings

In the factory settings, the functions “manual operation solar protection” up/down and “manual operation stop, slats” open/close are assigned to the building site function for all channels (outputs).

Programming mode

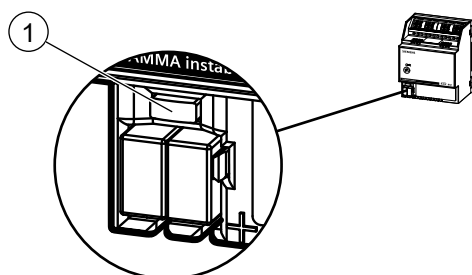

Fig. 1: Programming button and programming LED (exemplary illustration)



After bus voltage recovery, wait several seconds before pushing the programming (1) button (not before booting is complete).

Activate programming mode

- a) Briefly press the programming button (1) (< 2 seconds).
- ⇒ Programming mode is activated.
 - ⇒ The programming LED (1) illuminates continuously.

Deactivating programming mode

- ✓ Programming mode is activated. The programming LED (1) illuminates continuously.
- a) Briefly press the programming button (1) (< 2 seconds).
- ⇒ Programming mode is deactivated.
 - ⇒ The programming LED (1) is not illuminated.

Resetting the device to factory settings

A very long push of the programming button of more than 20 seconds resets the device to its factory settings. This is indicated by the programming LED flashing steadily for 8 seconds.

All configuration settings are deleted. The building site function of the delivery state is re-activated.

Behavior on unloading the application program

After unloading the application program with the ETS, the unloaded device has no functions.

Behavior on voltage failure/recovery

The electronics of the device are bus powered. Therefore, a grid voltage failure only leads to a functional failure of the device if the bus voltage also fails as a result of the grid voltage failure.

In case of bus voltage failure, the current status and other values for each channel are saved permanently so that they can be restored when the bus voltage is recovered.

When bus voltage is recovered, the configured actions for each channel are executed and, depending on the parameters set, new statuses are reported.

Each channel can be independently configured with parameters to define what status it is to assume in case of bus voltage failure (up, down, no change or stop). In addition, a starting behavior when bus voltage is recovered can be configured for each active override (e.g. alarms, moving blocks).

When bus voltage is recovered, one of the following functions can be selected as the starting value: Up, down, no change, as per parameter and stop. A delay can be configured for the starting value.

Direct operation

In direct operation, the solar protection actuator can be controlled using the buttons on the solar protection actuator. This enables the installer, for example, to check whether the solar protection actuator has been connected correctly.

After installation, the individual channels of the device can be tested directly on the device. Prior configuration via the software is not necessary for this.

Position and function of the operating and display elements [► 8]

Factory settings

In the factory settings (see also building site function), direct operation without time limits is activated.

After configuration, direct operation is limited to the configured time limit.

End position detection and automatic move time determination

The move time to defined element positions between the end positions can be analyzed automatically.

To this end, current sensing is used to detect if the upper or lower end position is reached in the context of the respective Up/Down command. The solar protection actuator features integrated electronics (current sensing via the transformer) that signalizes that an electromagnetic or electronic limit switch has triggered.

Direct control commands: Move Up / Down, Stop, Slat Adjustment

1-bit objects can be used to control the moving direction of the solar protection via Up and Down commands.

In the “Shutter” operating mode, an ongoing blind move for the respective channel can be stopped or, if the blind is stationary and a logical “0” is received, the slats can be opened by one step; if a logical “1” is received, they can be closed by one step.

Direct control commands: Move to positions 0...100 %

1-byte objects can be used to move the sunblind of the corresponding channel to any position between 0 and 100 % in manual operation and automatic operation.

In “Shutter” operating mode, the slats of the corresponding channel can also be moved into any position between 0 and 100 %.

Scene control

8-bit scene control

Using 8-bit scene control, current solar protection or slat positions can be assigned to a scene and retrieved.

Move to position 1/2, 3/4 (1-bit scene control)

The function “move to position 1/2, 3/4” is particularly suitable to repeatedly move to preferred element positions in combination with the 1-bit scene control.

The function can be used to specify 4 different solar protection positions for each channel. 2 of these preset positions (1/ 2 or 3/4) are addressed via one group address with the values "0" and "1."

The stored default settings of the positions can also be changed without programming the device via KNX. To do this, the blinds must be moved to the desired element height. This new position with the value "0" and "1" is copied to the memory of the device via the communication objects "position 1/2" (store) and "position 3/4" (store).

A preferred blind position can be called and stored at the push of a button. To do this, a key is pressed briefly to call up a position and a long key press is used to store it as a desired position.

Manual operation/automatic operation

The "manual operation" and "automatic operation" functions can be released separately for each channel via the ETS.

Manual operation is used for on-site control of the drives either individually or as a central command. Direct moving to element or slat positions is also possible here.

Automatic operation is configured for automated control of drives via a weather station. Automatic control via central commands is also possible.

When the sun is shining, sun tracking control of slats or shadow line tracking is implemented.

Central control

Each solar protection channel can be controlled centrally in manual operation and in automatic operation (manual operation solar protection central, automatic operation solar protection central). In addition, an individual delay time can be configured for time-delayed operation of the solar protection to avoid load peaks and noise pollution when starting up several drives.

Overrides

Up to seven different override function blocks can be activated via ETS to override the solar protection functions. The overrides can be configured per channel and individually.

For each of the override function blocks, one of the following functions can be selected: Wind Alarm, Rain Alarm, Frost Alarm, Lock, Forced position, Forced Control, Range limitation, User defined.

This enables flexible configuration of an individual priority-specific override for each channel. For the override functions a control value input can be selected instead of a switching control input.

Different priorities can be assigned to the override functions.

Range limitation

In order to not disturb the movement of the solar protection when windows, doors or skylights are open, the movement range can be restricted with an upper and lower limit.

Element settings

For exact positioning and adjustment of the elements, the move times between the respective end positions can be determined automatically. For this purpose, there are calibration runs, which can be configured.

An end position dead time can also be set for this.

Alternatively, the move times of the elements or the slat move times and step sizes for slats (shutters) can be set manually.

Advanced configuration

Specific settings for controlling the drives are offered. This includes, e.g. the swapping of the UP and DOWN connections. A reverse pause time is set to protect the motor.

A slip compensation time can be projected as slip compensation for a change in direction.

The drives can be controlled with start-up delays or run on for a configured time.

For safe end position detection, the threshold value for electricity can be adjusted. The electric current is evaluated in the process.

Status messages

Responses on element positions, such as dynamic element position, slat position, moves, moving directions, reaching the upper or lower end position are reported. In addition, responses to the different overrides, current operating mode such as direct operation or automatic operation can be displayed. In automatic end position detection, a status on the calibration of the move time is communicated.

Diagnostic functions

Load current overloads or contact faults can be reported.

Schematic design of a solar protection actuator channel

The following scheme shows the function of a channel of the solar protection actuator using the “blind” function in a logical context.

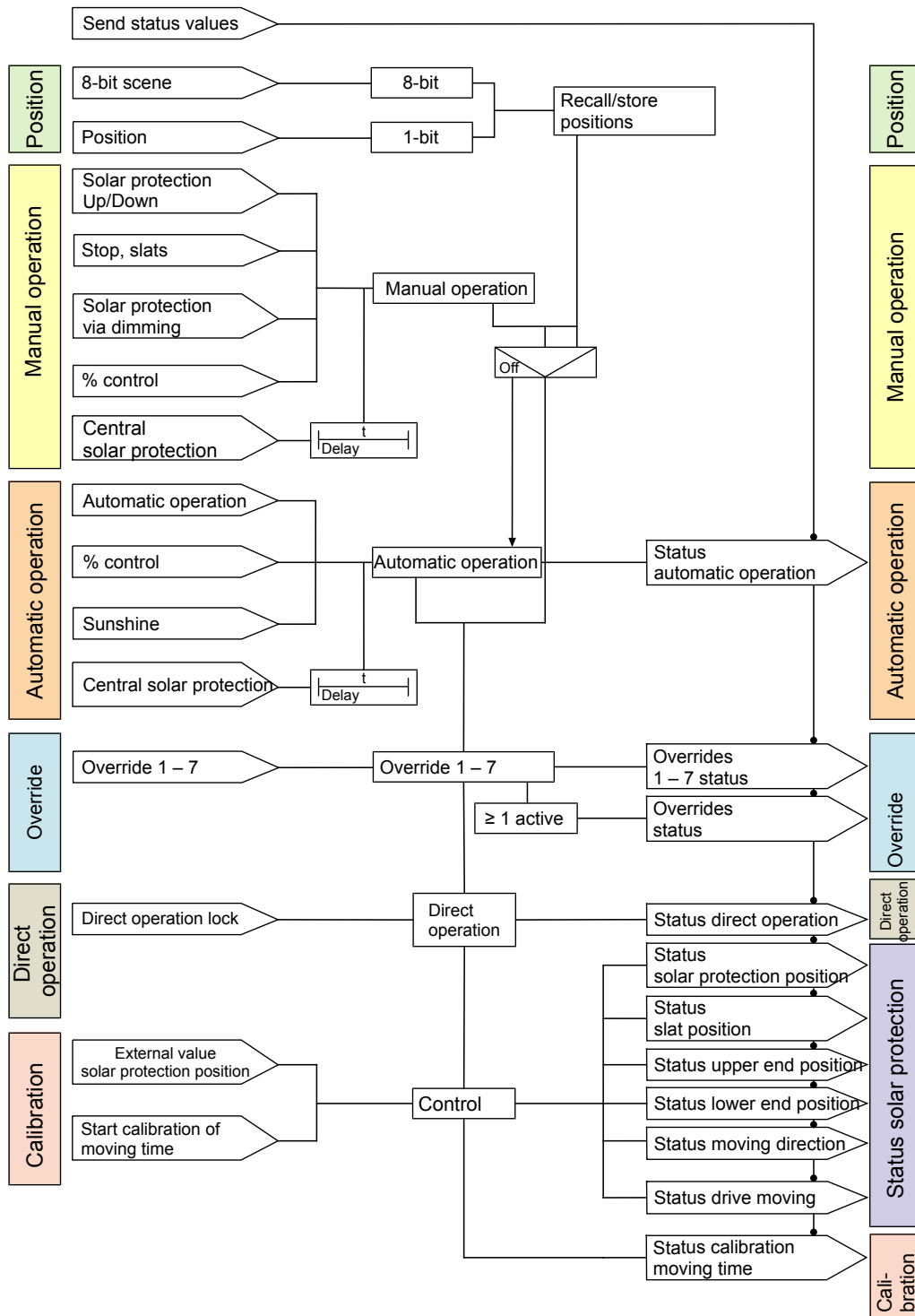

Position and function of the connections and labeling

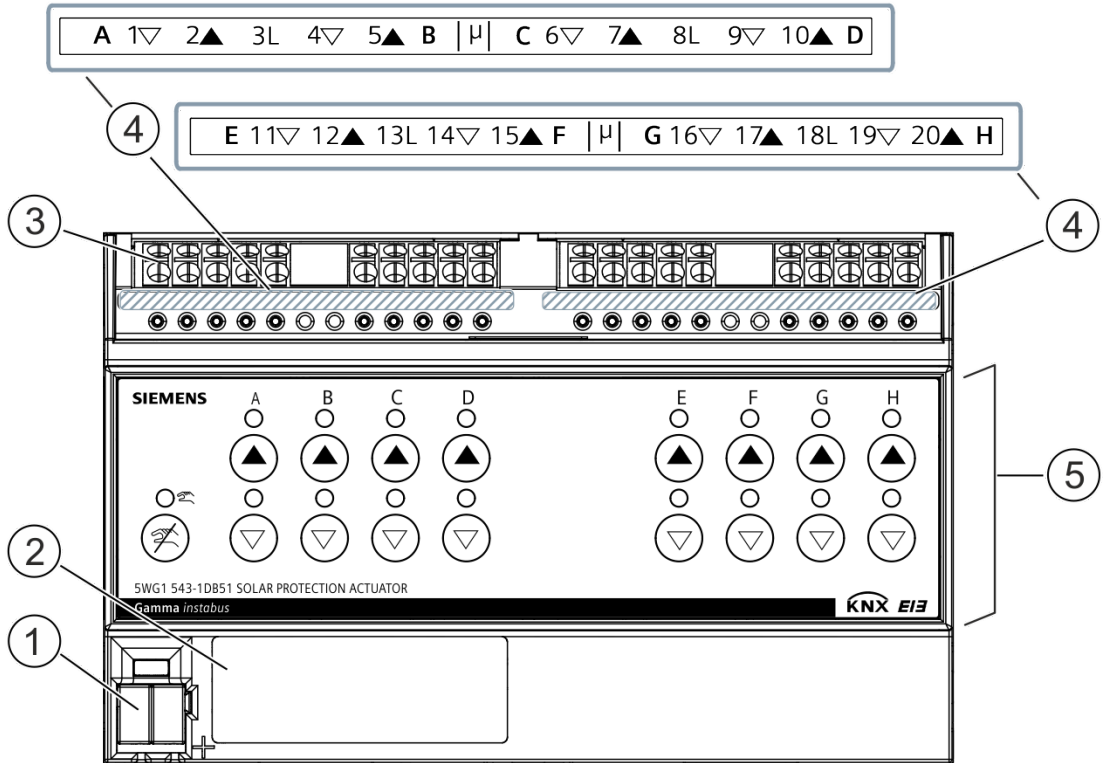

Fig. 2: Position and function of the connections and labeling,
Example: Solar protection actuator N 543D51, 8 x 6 A

Pos.	Element	Function
1	Connection pins for KNX bus terminal block, screwless	Connect KNX bus.
2	Label field	Enter physical address.
3	Connection terminals of the relay contacts	Connect input and loads.
4	Labeling of relay contacts for the drive channels	
5	Membrane keypad	Execute direct operation. Display movement direction and override.

Position and function of the operating and display elements

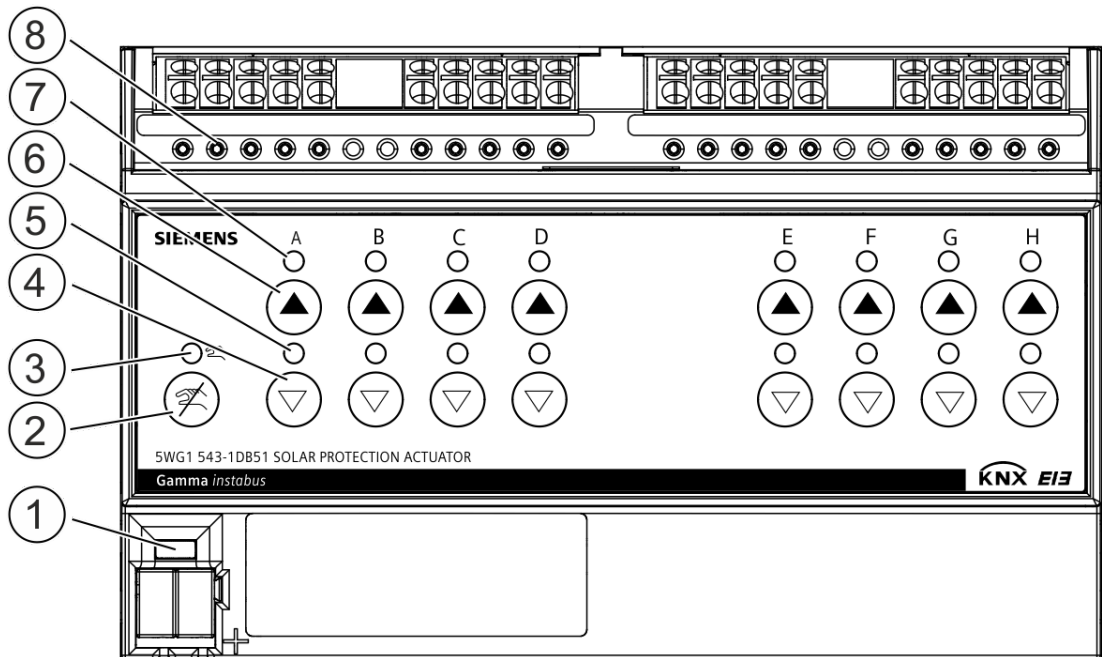



Fig. 3: Control and display elements, example: Solar protection actuator N 543D51, 8 x 6 A

Pos.	Operating or display elements	Function
1	Programming LED (red), Programming button	Short push of button (< 2 s): <ul style="list-style-type: none"> Activate programming mode, display status (LED on = active). Very long push of button (> 20 s): <ul style="list-style-type: none"> Reset to factory settings (after 20 s, the LED starts flashing for about 8 s).
2	Button: Deactivate direct operation	Short key press: <ul style="list-style-type: none"> Deactivate direct operation for all channels. Pressing the key and pressing the Stop/Slat Up/Down key (4, 6) of a channel: <ul style="list-style-type: none"> Deactivate the direct operation of the respective channel.
3	Status LED of direct operation (yellow)	LED flashes if direct operation is active for at least one channel.
4	Button: Stop/slat: "Up" move command of the channel	Short press of button (< 1 s): <ul style="list-style-type: none"> Move command "Stop" or "Lower" Activate direct operation for the channel. Long push of button (> 1 s): <ul style="list-style-type: none"> Move command "Down" active Activate direct operation for the channel.
5	Status LED of the channel, below (red)	Indicates the status of the respective channel. <ul style="list-style-type: none"> LED switched off: Direct operation is switched off. LED lit: Move command "Down" active. LED flashing in sync with status LED: Direct operation is switched on.

Pos.	Operating or display elements	Function
6	Button: Stop/slat: “Up” move command of the channel	Short press of button (< 1 s): <ul style="list-style-type: none"> Move command “Stop” or “Raise” Activate direct operation for the channel. Long push of button (> 1 s): <ul style="list-style-type: none"> Move command “Up” active Activate direct operation for the channel.
7	Status LED of the channel, below (red)	Indicates the status of the respective channel. <ul style="list-style-type: none"> LED switched off: Direct operation is switched off. LED lit: Move command “Up” active. LED flashing in sync with status LED: Direct operation is switched on.
5, 7	Status LEDs of the channel, above and below (red):	Both LEDs lit: Override active.
8	Test contacts	Metering point for voltage testing

Type overview

Type	Description	Article number	KNX PL-Link
 N 543D31	Solar protection actuator, 4 x 6 A	5WG1543-1DB31	yes
 N 543D51	Solar protection actuator, 8 x 6 A	5WG1543-1DB51	yes

Version of the Engineering Tool Software

Application	Version
Engineering Tool Software (ETS)	ETS 5 or above

Product documentation

Documents related the product, such as operating and installation instructions, application program description, product database, additional software and CE declarations can be downloaded from the following website:

<http://www.siemens.com/gamma-td>



Frequently asked questions

For frequently asked questions about the product and their solutions, see:

<https://support.industry.siemens.com/cs/products?dtp=FAQ&mfn=ps&lc=de-WW>



Support

Contact details for additional questions relating to the product:



Tel.: +49 89 9221 8000

<http://www.siemens.com/supportrequest>



Notes

Security

 CAUTION	
	<p>National safety regulations</p> <p>Failure to comply with national safety regulations may result in personal injury and property damage.</p> <ul style="list-style-type: none"> • Observe national provisions and comply with the appropriate safety regulations.
	<ul style="list-style-type: none"> • The device should only be installed and put into operation by a certified electrician. • When connecting the device, ensure that the device can be enabled. • Do not open the casing of the device. • Only use conventional transformers that comply with the relevant standards and contain a thermal fuse. • For planning and construction of electric installations, the relevant guidelines, regulations and standards of the respective country are to be considered. • Secure the phases with a B10 line protection switch.

Installation

The solar protection actuators can be used for fixed installations in interior spaces, for dry locations, within distribution boards or small casings with DIN rails EN 60715-TH35.

Connecting motors to the relay contacts

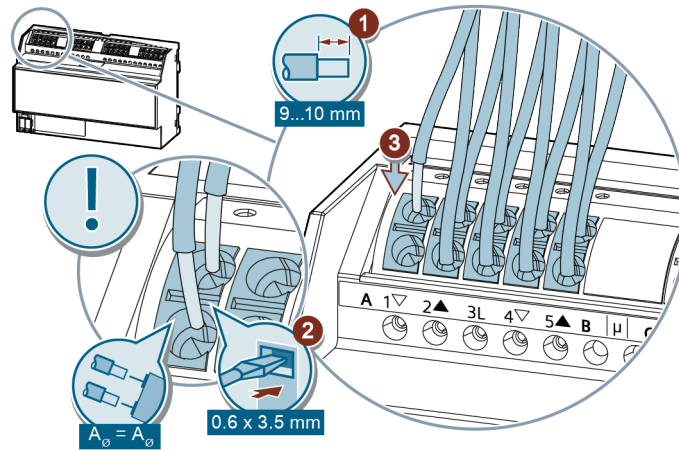
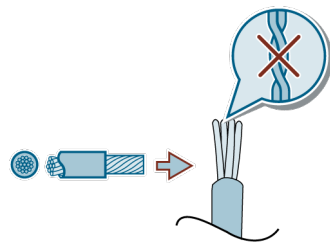

Fig. 4: Example: Solar protection actuator N 543D51, 8 x 6 A

Cu	
	0.5...2.5 mm ²
	2.5 mm ²



Connecting KNX

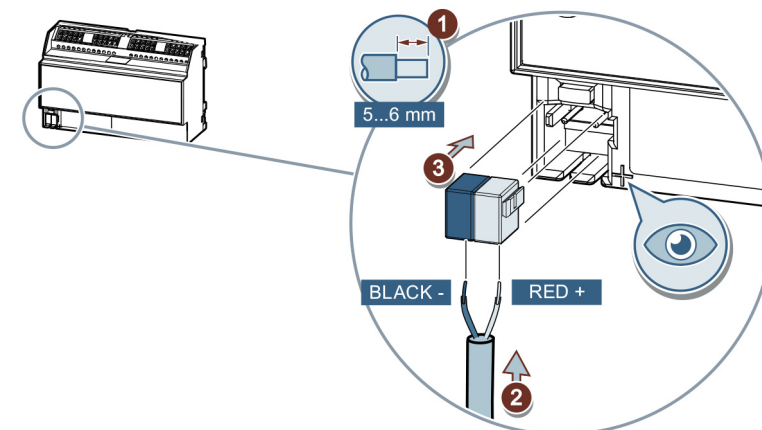

Fig. 5: Example: Solar protection actuator N 543D51, 8 x 6 A

Cu	
	0.6...0.8 mm

Testing KNX 24 V DC type. SELV

This test can be used to check whether the bus connection cable is connected with the correct polarity and whether device is supplied with bus voltage.

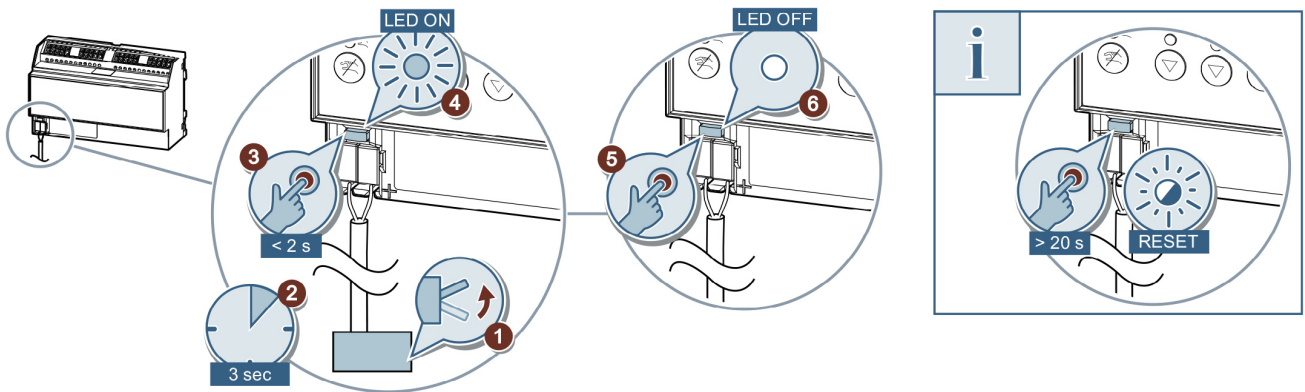

Fig. 6: Example: Solar protection actuator N 543D51, 8 x 6 A

Operation in direct operation (A|B|C|D|E|F|G|H Un~ 230 V)

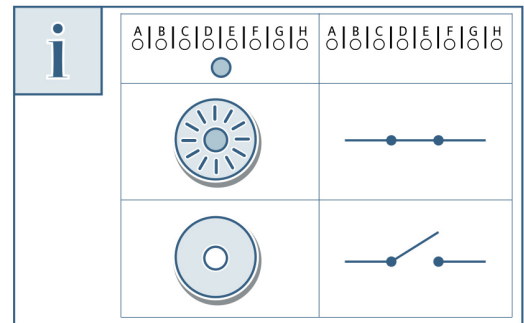
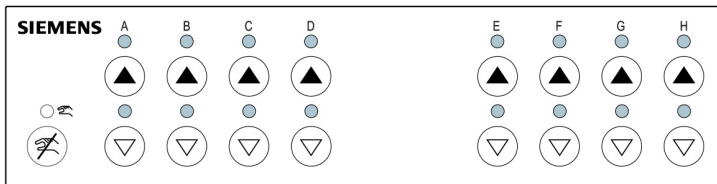

Fig. 7: Example: Solar protection actuator N 543D51, 8 x 6 A

Function test of the installation

This test can be used to check whether the motors have been connected correctly.

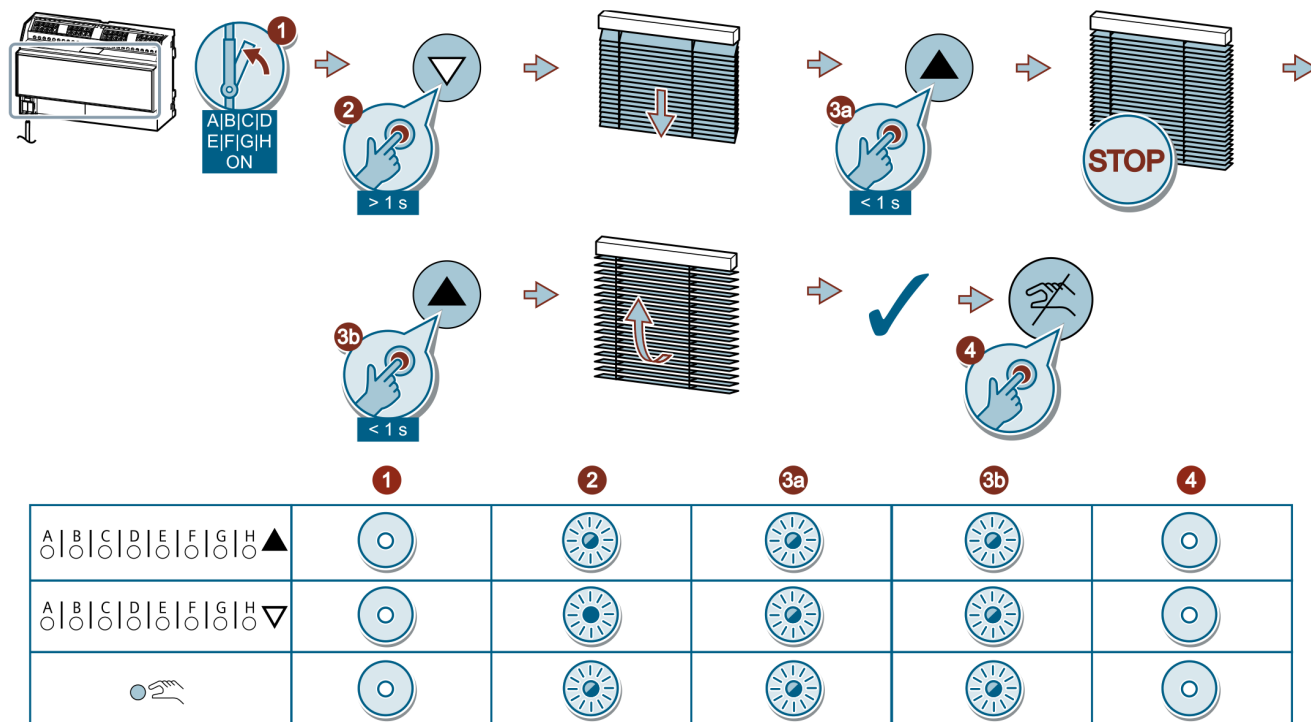

Fig. 8: Example: Solar protection actuator N 543D51, 8 x 6 A

Disposal



The device is considered an electronic device for disposal in accordance with European Directive and may not be disposed of as domestic waste.

- Use only designated channels for disposing the devices.
- Comply with all local and currently applicable laws and regulations.



If a device is defective, contact the local sales office.

Type	N 543D31	N 543D51
Power supply		
KNX bus voltage	DC 24 V (DC 21...30 V)	DC 24 V (DC 21...30 V)
KNX bus current	15 mA	20 mA
KNX power loss (internal consumption)	0.15 W	0.17 W

Type	N 543D31	N 543D51
KNX medium	TP1-256	TP1-256

Type	N 543D31	N 543D51
Drive channels		
2 relay contacts per channel, electromagnetically locked against one another	4	8
Contact voltage		
Rated voltage	230 V AC	230 V AC
Contact current		
Rated current, AC (resistive load)	6 A	6 A
Current sensing for travel time determination	≥ 75 mA	≥ 75 mA

Type	N 543D31	N 543D51
Service life		
Mechanical lifespan	50,000,000 switching cycles	50,000,000 switching cycles
Electrical lifespan	100,000 switching cycles	100,000 switching cycles
Power loss		
Maximum power loss per device at rated output	2.8 W	5.5 W
Maximum power loss per output at rated output	0.66 W	0.66 W
Switching capacities/load types, loads		
Resistive load	1380 W	1380 W
Minimum switching capacity	5 V 10 mA	5 V 10 mA
Maximum DC1 breaking capacity	30 V 6 A	30 V 6 A

Type	N 543D31	N 543D51
Mechanical data		
Housing material	Plastic	Plastic
Dimensions	Rail-mounted device in N dimension, width 4 TE (1 TE = 18 mm) See dimension drawing [▶ 16]	Rail-mounted device in N dimension, width 8 TE (1 TE = 18 mm) See dimension drawing [▶ 16]
Weight	246 g	450 g

Type	N 543D31	N 543D51
Mechanical data		
Fire load	5 MJ	9 MJ

Environmental conditions	
Ambient temperature in operation	-5 °C...+45 °C (23 °F...113 °F)
Storage temperature	-20 °C...+70 °C (-4 °F...158 °F)
Transport temperature	-25 °C...+70 °C (-13 °F...158 °F)
Relative humidity (non-condensing)	5 %...95 %
Climatic resistance	EN 50428

Protection settings	
Degree of pollution (according to IEC 60664-1)	2
Overvoltage category (according to IEC 60664-1)	III
Protection class (according to EN 60529)	IP20
Electrical safety, bus	yes
Electrical safety, device complies with	EN 50428
EMC requirements, device complies with	EN 50428
Test mark	KNX, EAC, RCM, WEEE, China-RoHS
CE mark	yes

Type	N 543D31	N 543D51
Reliability		
Failure rate (at 40°C)	1776 fit	3816 fit

Connection example

The following connection example shows the connection of 6 AC motors for control (up/down or open/close) e.g. of solar protection, door, window or ventilation flaps via channels A, B, C, D, G and H.

The transformers are used to detect the activation of electromagnetic and electronic end position switches.

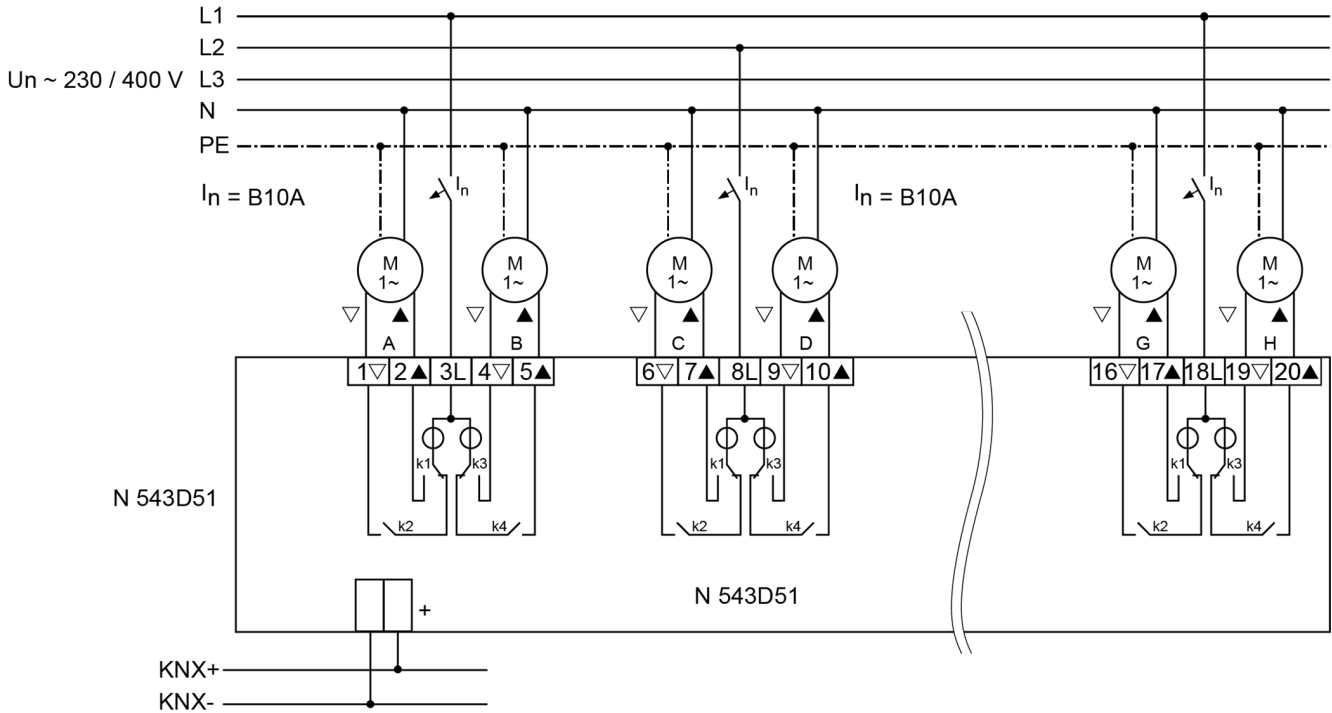

Fig. 9: Example: Solar protection actuator N 543D51, 8 x 6 A

Dimensions

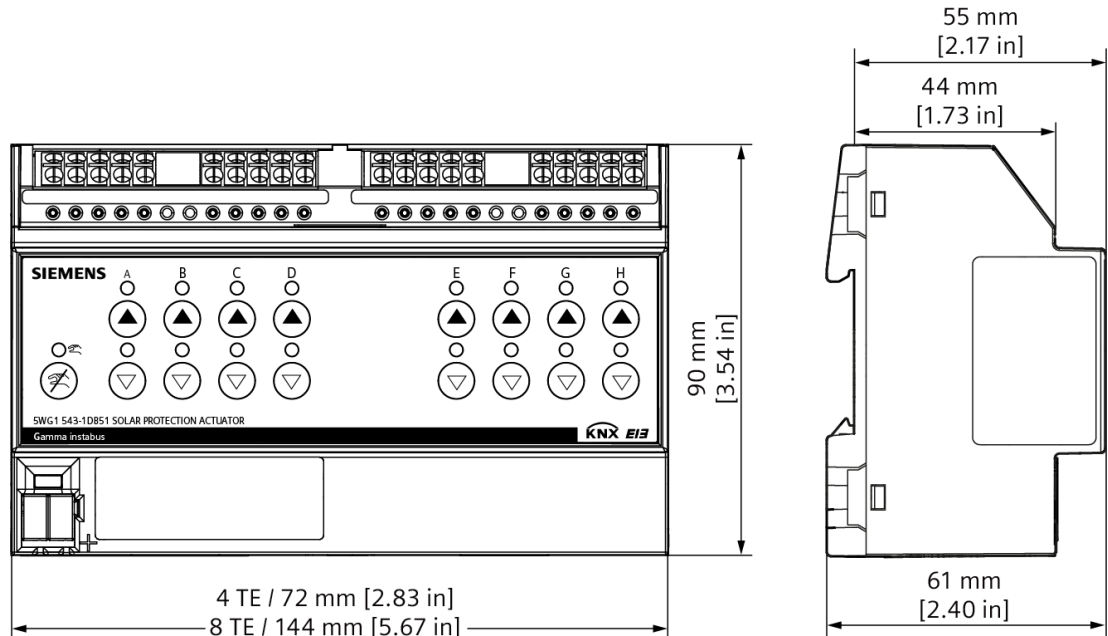



Fig. 10: Example: Solar protection actuator N 543D51, 8 x 6 A

FCC Statement

⚠ WARNING	
	<p>Installation and usage of equipment not in accordance with instructions manual may result in:</p> <p>Radiation of radio frequency energy Interference to radio communications</p> <ul style="list-style-type: none"> ● Install and use equipment in accordance with installation instructions manual ● Read the following information

This equipment generates, uses, and can radiate radio frequency energy and if not installed and used in accordance with the instructions manual, may cause interference to radio communications.

It has been tested and found to comply with the limits for a Class A computing device pursuant to Part 15 of FCC Rules, which are designed to provide reasonable protection against such interference when operated in a commercial environment.

Operation of this equipment in a residential area is likely to cause interference in which case the user at his own expense will be required to take whatever measures may be required to correct the interference.

FCC Statement

This equipment has been tested and found to comply with the limits for a Class B digital device, pursuant to part 15 of the FCC Rules. These limits are designed to provide reasonable protection against harmful interference in a residential installation. This equipment generates, uses and can radiate radio frequency energy and, if not installed and used in accordance with the instructions, may cause harmful interference to radio communications. However, there is no guarantee that interference will not occur in a particular installation. If this equipment does cause harmful interference to radio or television reception, which can be determined by turning the equipment off and on, the user is encouraged to try to correct the interference by one or more of the following measures:

- Reorient or relocate the receiving antenna.
- Increase the separation between the equipment and receiver.
- Connect the equipment into an outlet on a circuit different from that to which the receiver is connected.
- Consult the dealer or an experienced radio/TV technician for help.

This device complies with Part 15 of the FCC rules. Operation is subject to the following two conditions:

1. This device may not cause harmful interference, and
2. this device must accept any interference received, including interference that may cause undesired operation

FCC Caution: Changes or modifications not expressly approved by Siemens Switzerland Ltd. could void the user's authority to operate the equipment. United States representative <https://new.siemens.com/us/en/products/buildingtechnologies/home.html>

Industry Canada statement

This device complies with ISSED's license-exempt RSSs. Operation is subject to the following two conditions:

1. This device may not cause interference, and
2. This device must accept any interference received, including interference that may cause undesired operation.

Issued by
Siemens Switzerland Ltd
Smart Infrastructure
Global Headquarters
Theilerstrasse 1a
CH-6300 Zug
+41 58 724 2424
www.siemens.com/buildingtechnologies

© Siemens Switzerland Ltd, 2022
Technical specifications and availability subject to change without notice.

Document ID A6V11986596_en--_e
Edition 2022-12-07