

599 Series

Zone Valve Actuator

SF Series Electronic Valve Actuator, 2-position Control

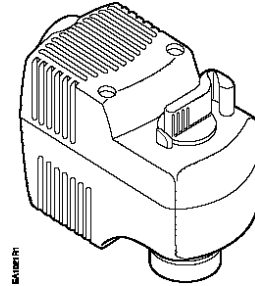

Description The 599 SF Series electronic zone valve actuators, accept 24 Vac or 120 Vac power supply signal to provide two-position control. This actuator works with Siemens 599 Series zone valves with 1/10-inch (2.5 mm) stroke.

- Features**
- UL listed for plenum installations
 - Direct coupled installation without tools
 - Manual override
 - Visual position indication
 - Spring return fail-safe operation

Application For use in heating and cooling HVAC applications with Siemens 599 Series Zone Valves that need 24 lb (105N) nominal force.

Product Number



Table 1.

| | Actuator Product Number | Power Supply |
|----|-------------------------|--------------|
| NO | SFP71U | 24 Vac |
| | SFP11U | 120 Vac |
| NC | SFA71U | 24 Vac |
| | SFA11U | 120 Vac |

Ordering Information To order a complete valve plus actuator assembly from the factory, combine the actuator prefix code with the suffix of the valve product number. See *Technical Bulletin TB254* (155-291) for selection procedures.

To order a single actuator, use the part number (for example, SFA11U).

Warning/Caution Notations

| | | |
|-----------------|---|---|
| WARNING: |  | Personal injury or loss of life may occur if you do not perform a procedure as specified. |
| CAUTION: |  | Equipment damage may occur if you do not perform a procedure as specified. |

| Specifications | | 24 Vac | 120 Vac |
|-----------------------------|-------------------------|--|---------------------|
| Power supply | Frequency | 50/60 Hz | 60 Hz |
| | Power consumption | 9.8 VA 5.8 ~ 6.9 W | 9.8 VA 4 ~ 5.8 W |
| Function | Running time | 10 seconds | |
| | Nominal stroke | 1/10-inch (2.5 mm) | |
| | Nominal force | 24 lb (105Nm) | |
| Agency certification | | UL listed to UL873 cUL certified to Canadian Standard C22.2 No. 24-93 | |
| | | | |
| Ambient conditions | Operation | | |
| | Temperature | 41°F to 122°F (5°C to 50°C) | |
| | Humidity | 0% to 90% rh (non-condensing) | |
| | Transport and storage | | |
| | Temperature | -13°F to 158°F (-25°C to 70°C) | |
| | Humidity | 0% to 90% rh (non-condensing) | |
| Miscellaneous | Lead length | | |
| | SFA/SFP11U | 20 inches (508 mm) | |
| | SFA/SFP71U | 10 inches (254 mm) | |
| | Mounting location | NEMA 1 (interior only) | |
| | Noise | <35 db | |
| | Medium temperature | 34°F to 230°F (1°C to 110°C) | |
| | Dimensions- Inches (mm) | 3.4 (85.2) H x 4.4 (111) W x 2.3 (58) D | |
| | Weight | 1.18 lb (0.54 kg) | |

Operation

A 24 Vac or 120 Vac control signal drives the actuator from its normal (0 voltage) position.

In the event of power loss, the actuator will return to its normal extended position for the SFA model actuators or normal retracted position for the SFP models.



CAUTION:

Actuator life may be reduced under either of these conditions:

- Use of SFP actuators in hot water systems that remain operational all year long, with actuators continually commanded closed during the non-heating season
- Use of SFA actuators in chilled water systems that remain operational all year long, with actuators continually commanded open during the non-cooling season

Mounting and Installation

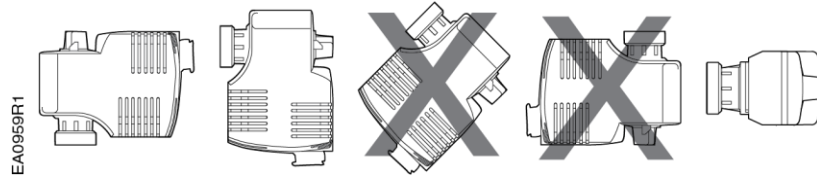
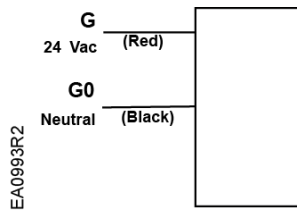

Figure 1. Mounting Position.

- Mount the actuator in one of the allowable positions shown in Figure 1.
- When mounting the actuator in a plenum, the proper cable must be attached to meet local codes.
- Allow 8 inches (200 mm) above the actuator and 8 inches (200 mm) behind the cable for service.
- Installation Instructions are included with the actuator.

Wiring



**Figure 2.
24 Vac Wiring Diagram.**

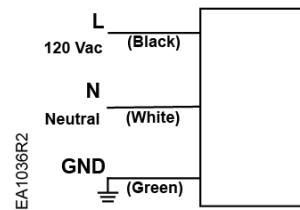

**Figure 3.
120 Vac Wiring Diagram.**



WARNING:

Wire connection, G is Hot, not ground.

- Do not use autotransformers.
- Use earth-ground isolating, step-down, Class 2, power supplies.
- Determine supply transformer rating by summing total VA of all actuators used.
- SFA71U/SFP71U 24 Vac actuators: Wiring connection is inside the actuator housing (remove housing top for access). The actuator lead length is 10 inches (254 mm).
- SFA11U/SFP11U 120 Vac actuators: Wiring connection requires junction box and flex conduit no further than 15 inches (381 mm) from the actuator. The actuator lead length is 20 inches (508 mm).

NOTE: One transformer should power no more than 10 actuators.

Manual Override

For manual positioning, simply turn the manual override handle to the protruding stop and squeeze the handle to latch and hold its position.

The actuator will maintain its position until power is provided.

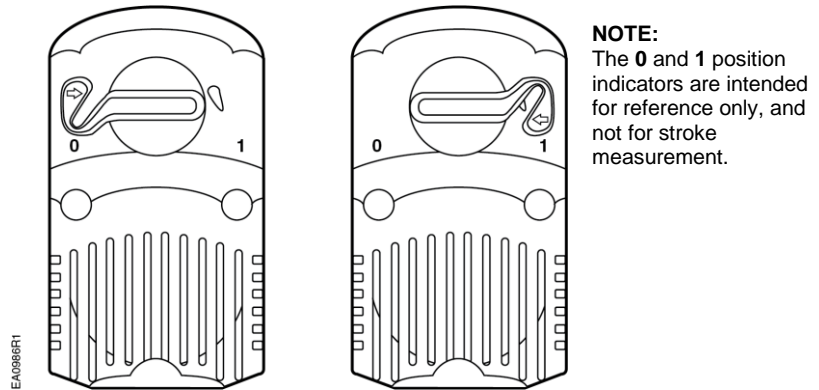

Figure 4. Manual Override Handle Positioning.

Start-Up

Check the wiring and the position indication.

When the position indicator is in the **0** position:

SFP: The output shaft will be retracted; the actuator is Normally Open. See Figure 5.

SFA: The output shaft will be extended; the actuator is Normally Closed. See Figure 6.

When the position indicator is in the **1** position, the reverse is true.

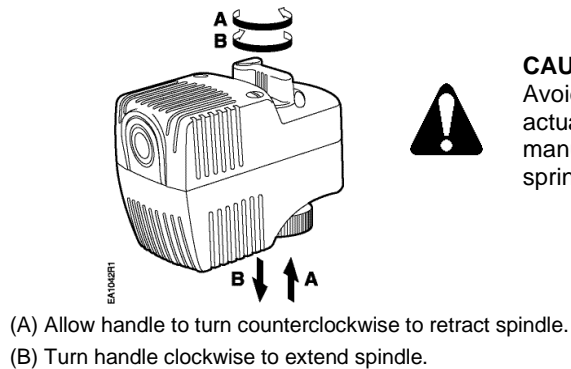

Figure 5. SFP Models, Normally Open.

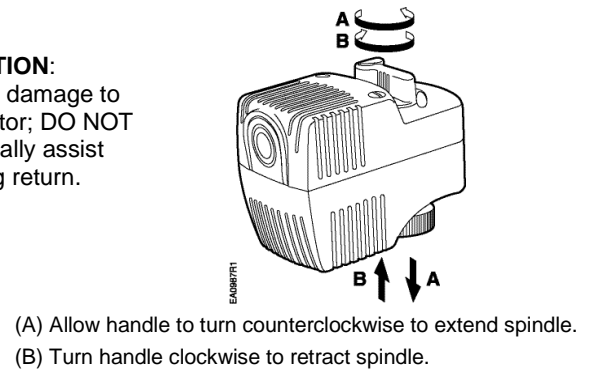

Figure 6. SFA Models, Normally Closed.

Troubleshooting See *Wiring* for proper connections.

Service Kits If the actuator is inoperative, replace the unit.

Dimensions

Inches (Millimeters)

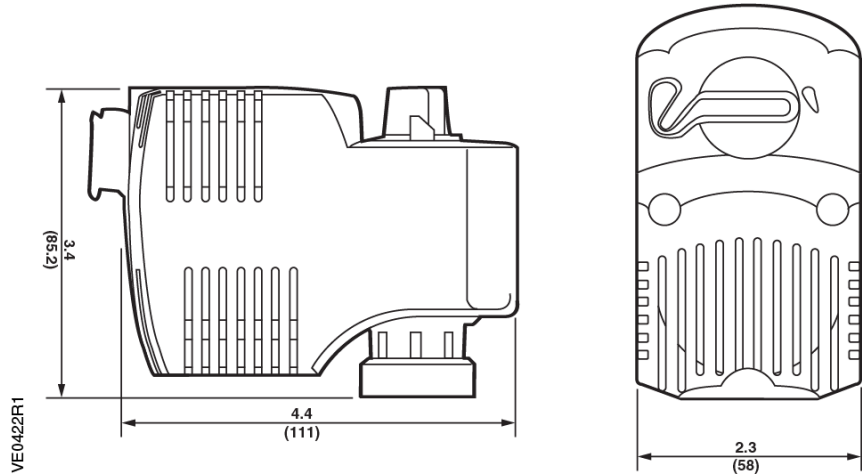

Figure 7. Dimensions of the SFx Series Actuator.

Service Envelope

Minimum access space recommended:

8 inches (200 mm) above the actuator and beside the terminal plug.

Information in this publication is based on current specifications. The company reserves the right to make changes in specifications and models as design improvements are introduced. Product or company names mentioned herein may be the trademarks of their respective owners.
© 2021-2023 Siemens Industry, Inc.