

Flowrite™ VF 599 Series

Three-Way Valves 2-1/2 to 6-inch Flanged Iron Body

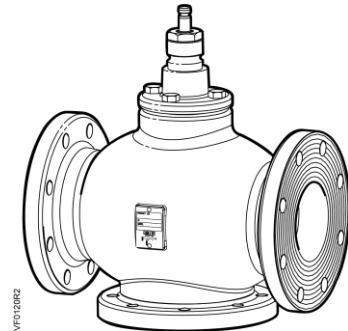

Description The Flowrite VF 599 Series three-way valves are designed to work with either a pneumatic or electronic actuator. They are available in both ANSI Class 125 and 250.

- Features**
- Valve flange face-to-face dimensions meet ISA 75.03 standards
 - Direct coupled universal bonnet
 - Choice of bronze or stainless steel trim
 - ANSI Leakage Class IV (0.01% of Cv)
 - Cartridge type packing
 - Optional service flange available

Application A typical application for the Flowrite three-way valve is the mixing of two different temperatures of water supplies.

The valve can also be used for throttling or bypass coil control applications. A pump is recommended on the coil circuit to improve the heat transfer characteristics of the coil and for freeze protection.

Product Numbers

Table 1. Product Numbers for Three-Way Valve Assemblies.

Flow Rate		Line Size		Stroke		ANSI Class 125		ANSI Class 250	
Cv	(Kvs)	Inch	(mm)	Inch	(mm)	Stainless Steel Trim	Bronze Trim	Stainless Steel Trim	Bronze Trim
63	(54)	2-1/2	(65)	3/4	(20)	599-06165	599-06160	599-06175	599-06170
100	(85)	3	(80)	3/4	(20)	599-06166	599-06161	599-06176	599-06171
160	(137)	4	(100)	1-1/2	(40)	599-06167	599-06162	599-06177	599-06172
250	(214)	5	(125)	1-1/2	(40)	599-06168	599-06163	599-06178	599-06173
400	(340)	6	(150)	1-1/2	(40)	599-06169	599-06164	599-06179	599-06174

Ordering a Valve Plus Actuator Assembly

To order a complete valve plus actuator assembly from the factory, combine the actuator prefix code with the suffix of the valve assembly product number. See *Flowrite™ 599 Series - 2-1/2 to 6-Inch Valve, Two-Way & Three-Way, and Actuator Assembly Selection Technical Bulletin* (155-776 [TB 256]) for selection procedure and ordering codes.

Valve assemblies can be ordered using the numbers in Table 1.

The service flange is ordered separately.

Specifications

Line size	2-1/2 to 6 inches (65 to 150 mm)
Capacity	See Table 6, Table 7, and Figure 2.
Body style	Flanged
Seat style	Metal-to-metal
Action	Three-way water mixing
Valve body rating	See Table 5.
Stem travel (Stroke)	
2-1/2 and 3-inch	3/4-inch (20 mm)
4, 5, and 6-inch	1-1/2 inches (40 mm)

Material

Body	Cast iron ASTM A 126 Class B
Body trim	See Table 1.
Stem	Stainless steel ASTM A582 Type 303
Packing	Double EPDM O-rings
Liquid service to 250°F (120°C)	
Controlled medium	Water, glycol solutions to 50%
Medium temperature range	20°F to 250°F (−7°C to 120°C)

Operating

Maximum inlet pressure	See Table 5.
Maximum recommended differential pressure for modulating service	
Bronze trim	25 psi (173 kPa)
Stainless steel trim	50 psi (345 kPa).
Rangeability	>100:1
Close-off pressures	See Table 8, Table 9, and Figure 3.
Close-off ratings	According to ANSI/FCI 70-2
Leakage rate	Class IV (0.01% of Cv)
Flow characteristics	Equal percentage for NC Linear for NO

Miscellaneous

Canadian Registration Numbers	OC24303.5
Mounting location	NEMA 1 (interior only)
Mounting according to ANSI B16.1	See <i>Cast Iron Flange Dimensions for 2-1/2 through 6-inch Valves Technical Bulletin</i> (155-303P25 [TB 248])
Dimensions	See Table 11, Table 12, and Figure 5.
Face-to-face dimensions	ANSI/ISA S75.03
Valve weight	See Table 12.

Accessories

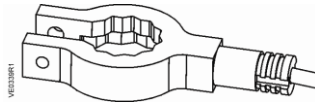

Figure 1. Stem Heating Element.

ASZ6.6 The stem heating element prevents the formation of ice on the stem when the medium temperature drops below 32°F (0°C). It is suited for universal use with valves having a stem or spindle diameter of 10 or 14 mm.

Operating Voltage 24 Vac/dc ± 20%

Power consumption ≤ 40 VA/30W

Service Kits

Valve packing kit	599-08020
Rebuild/repack kits	See Table 2.
Service flange	See Table 3.
Flange gaskets and bolts	See Table 4.
Stem retainer kit: 2-1/2 inch and 3-inch valves	599-10048
Stem retainer kit: 4, 5, and 6-inch valves	599-10049
Lower seat tool	See Table 10.

Rebuild/repack kit

To select the rebuild/repack service kit, know your valve body assembly number. The valve body assembly number is stamped on the tag on the valve body.

Table 2. Rebuild/Repack Service Kit Part Numbers.

Trim	Valve Size Inches (mm)	ANSI Class 125 Valve No.	ANSI Class 250 Valve No.	Kit No.
Bronze	2-1/2 (65)	599-06160	599-06170	599-10125
	3 (85)	599-06161	599-06171	599-10126
	4 (100)	599-06162	599-06172	599-10127
	5 (125)	599-06163	599-06173	599-10128
	6 (150)	599-06164	599-06174	599-10129
Stainless Steel	2-1/2 (65)	599-06165	599-06175	599-10120
	3 (85)	599-06166	599-06176	599-10121
	4 (100)	599-06167	599-06177	599-10122
	5 (125)	599-06168	599-06178	599-10123
	6 (150)	599-06169	599-06179	599-10124

Service Flanges

Table 3. Part Numbers for VF 599 Service Flanges.

Line Size Inches (mm)	Service Flange Part Numbers	
	ANSI Class 125	ANSI Class 250
2-1/2 (65)	599-05011	599-05016
3 (80)	599-05012	599-05017
4 (100)	599-05013	599-05018
5 (125)	599-05014	599-05019
6 (150)	599-05015	599-05020

Flange Gasket and Bolt Kits

Table 4. Part Numbers for VF 599 Flange Gasket and Bolt Kits.

Description	Line Size Inch (mm)	Kit Part Number	Cap Screw Size - Inch
ANSI Class 125	2-1/2 (65)	599-09236	5/8 – 11 x 1-1/2
	3 (80)	599-09237	5/8 – 11 x 1-3/4
	4 (100)	599-09238	5/8 – 11 x 2
	5 (125)	599-09239	3/4 – 10 x 2
	6 (150)	599-09240	3/4 – 10 x 2
ANSI Class 250	2-1/2 (65)	599-09241	3/4 – 10 x 2
	3 (80)	599-09242	3/4 – 10 x 2-1/2
	4 (100)	599-09243	3/4 – 10 x 2-1/2
	5 (125)	599-09244	3/4 – 10 x 2-3/4
	6 (150)	599-09245	3/4 – 10 x 3

Tables

Table 5. Cast Iron Valve Body Ratings.

Temperature		Pressure psig (kPa)	
°F	°C	ANSI Class 125	ANSI Class 250
-20 to 150	-30 to 66	200 (1387)	500 (3447)
200	93	190 (1310)	460 (3171)
250	121	175 (1206)	415 (2861)
300	149	165 (1137)	375 (2585)
400	204	140 (965)	290 (1999)
450	232	125 (861)	250 (1723)

**Table 6. Maximum Water Capacity - U.S. Gallons Per Minute.
Flow is Equal Through Both Ports.**

Valve Size in Inches	Pressure Differential - psi															
	Cv/1	2	3	4	5	6	8	10	15	20	25	30	40	50	60	75
2-1/2	63	89	109	126	141	154	178	199	244	282	315	345	398	445	488	546
3	100	141	173	200	224	245	283	316	387	447	500	548	632	707	775	866
4	160	226	277	320	358	392	453	506	620	716	800	876	1012	1131	1239	1386
5	250	354	433	500	559	612	707	791	968	1118	1250	1369	1581	1768	1936	2165
6	400	566	693	800	894	980	1131	1265	1549	1789	2000	2191	2530	2828	3098	3464

**Table 7. Maximum Water Capacity - Cubic Meters Per Hour (m³/hr)
Flow is Equal Through Both Ports.**

Valve Size in mm	Pressure Differential - kPa														
	1	10	20	30	40	50	60	80	Kvs/100	150	200	300	400	500	
65	5.4	17.1	24	30	34	38	42	48	54	66	76	94	108	121	
80	8.5	27	38	47	54	60	66	76	85	104	120	147	170	190	
100	14	43	61	75	87	97	106	123	137	168	194	237	274	306	
125	21	68	96	117	135	151	166	191	214	262	303	371	428	479	
150	34	108	153	187	216	242	265	306	342	419	484	592	684	765	

Table 8. Close-off Pressures for Electronic Actuators.

Action	Valve Size Inches (mm)	SKB/C		SKD		Rack & Pinion Spring Return		SAX Non-Spring Return	
		psi	(kPa)	psi	(kPa)	psi	(kPa)	psi	(kPa)
Normally Open	2-1/2 (65)	153	(518)	38	(262)	26	(179)	26	(179)
	3 (80)	101	(342)	25	(172)	17	(117)	17	(117)
	4 (100)	65	(448)	—	—	—	—	—	—
	5 (125)	42	(289)	—	—	—	—	—	—
	6 (150)	29	(199)	—	—	—	—	—	—
Normally Closed	2-1/2 (65)	97	(668)	34	(234)	26	(179)	26	(179)
	3 (80)	63	(434)	22	(152)	17	(117)	17	(117)
	4 (100)	39	(268)	—	—	—	—	—	—
	5 (125)	25	(172)	—	—	—	—	—	—
	6 (150)	17	(117)	—	—	—	—	—	—

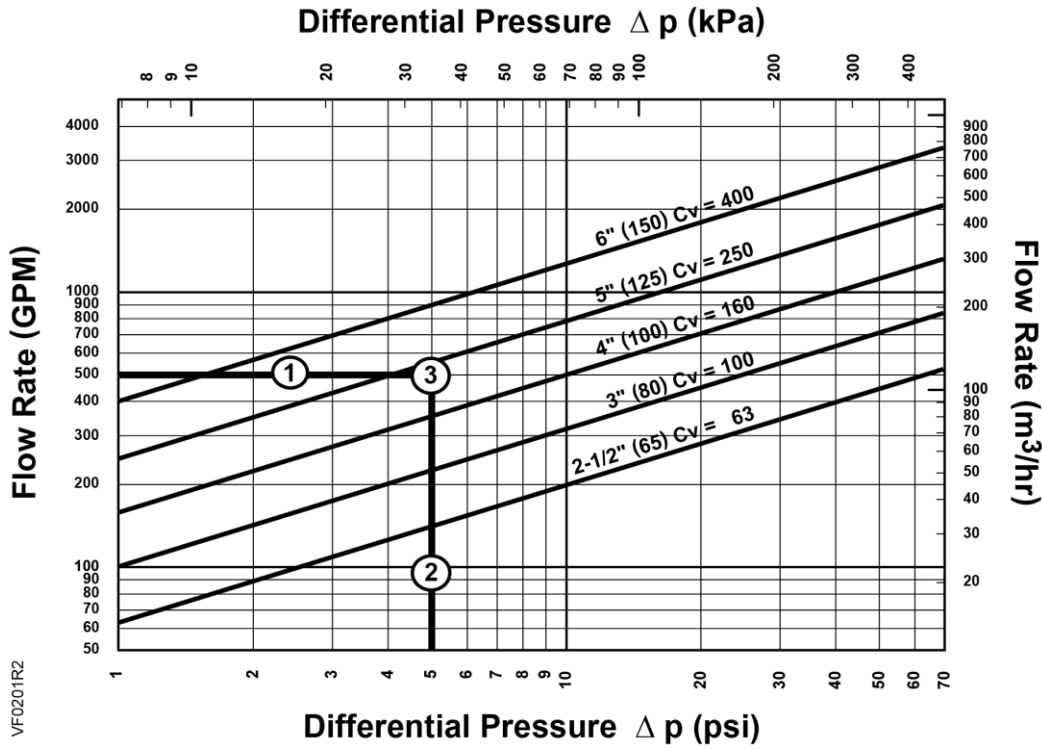

Figure 2. Water Capacity Graph.

Selection Example

Select a valve given:

- 1 = Required flow = 500 gpm
- 2 = Desired pressure drop = 5 psi
- 3 = Select a 5-inch (125 mm) valve, Cv 250.

Table 9. Close-off Pressures for Pneumatic Actuators.

Action	Valve Size Inches (mm)	8-inch Actuator		12-inch Actuator	
		15 psi (103 kPa)	30 psi (207 kPa)	15 psi (103 kPa)	30 psi (207 kPa)
Normally Open	2-1/2 (65)	31 (213)	100 (689)	95 (655)	304 (2096)
	3 (80)	20 (44)	66 (144)	63 (434)	200 (1378)
	4 (100)	—	—	40 (275)	129 (889)
	5 (125)	—	—	26 (179)	82 (565)
	6 (150)	—	—	18 (124)	57 (393)
Normally Closed	Valve Size Inches (mm)	5 to 10 psi (34 to 69 kPa) Spring Range			
		8-inch Actuator		12-inch Actuator	
		0 psi (0 kPa)		0 psi (0 kPa)	
	2-1/2 (65)	36 (248)		114 (786)	
	3 (80)	23 (158)		74 (510)	
	4 (100)	—		46 (317)	
	5 (125)	—		29 (199)	
6 (150)	—		20 (137)		

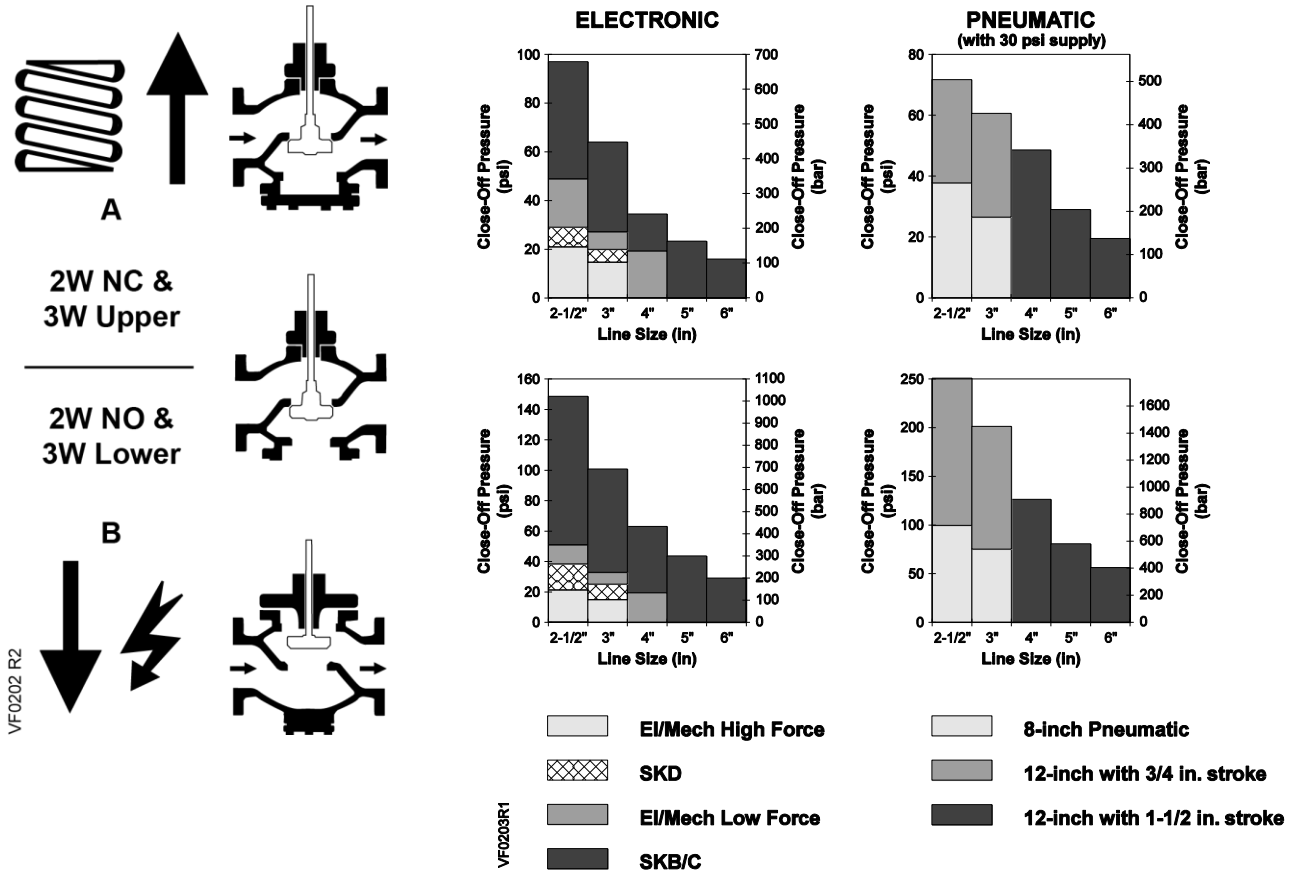

Figure 3. Close-off Pressures.

Operation

This Flowrite three-way valve is designed as a mixing valve.

As the valve stem moves downward, the flow through the NO port decreases and the flow through the NC port increases. As the valve stem moves upward, the flow through the NO port increases and the flow through the NC port decreases.

In the event of power failure, a spring return actuator returns the valve to its normal position. Non-spring return actuators will hold the last commanded position. See the Technical Instructions of the various actuators for additional information.

If this valve is used in diverting applications, the following conditions apply:

Diverting service with modulating control can only use the electro-hydraulic actuator, SKB/C. The differential pressure must not exceed 90% of the maximum differential pressure specified for the three-way valve in mixing service.

Diverting service with a pneumatic actuator can only be used with two-position control. To change over from one port to another, there must be no system pressure. The pump is turned off.

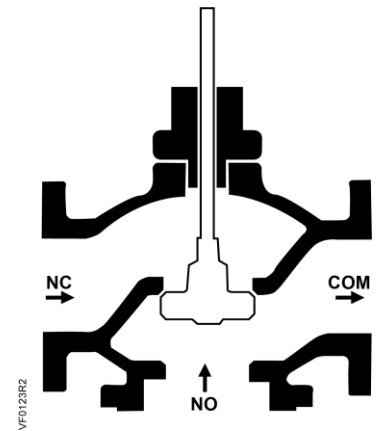

Figure 4. Three-Way Valve Operation as a Mixing Valve.

Sizing

The sizing of a valve is important for correct system operation. An undersized valve will not have sufficient capacity at maximum load. An oversized valve may initiate cycling and the seat and throttling plug can be damaged because of the restricted opening. Correct sizing of the control valve for actual expected conditions is considered essential for good control.

Some variables which must be determined are:

- The medium to be controlled: water, etc.
- The maximum inlet temperature and pressure of the medium at the valve.
- The pressure differential that will exist across the valve under maximum load demand.
- The maximum capacity the valve must deliver.
- The maximum line pressure differential the valve actuator must close against.
- See AB-1 *Control Valve Selection and Sizing* (155-285) for further recommendations.

See Table 6 and Table 7 for valve capacities.

Mounting and Installation

- Install the valve so that the flow follows the direction of the arrow indicated on the valve body identification tag.
- For best performance, install the valve assembly with the actuator above the valve body. The valve and actuator can be installed in any position between vertical and horizontal. Siemens Building Technologies does not recommend installing the valve assembly below horizontal or upside down.
- If installing a service flange, see Table 13 for proper placement.
- For flange dimensions and bolt hole information, see *Cast Iron Flange Dimensions for 2-1/2 through 6-inch Valves Technical Bulletin* (140-0038 [TB 248]. Allow sufficient space for servicing the valve and actuator. See Table 12 for valve body dimensions. See Table 11 and Figure 5 for dimensions of the service envelope recommended around the actuator.
- A lower seat tool is required for removing a three-way valve. See Table 10 for part numbers.

NOTE: Instructions for field mounting an actuator, spring adjustments, wiring diagrams, and start-up are covered in the Technical Instructions and Installation Instructions for each actuator.

Table 10. Three-Way Valve Lower Seat Tool.

Part Number	Valve Size Inches (mm)
599-09144	2-1/2 (65)
599-09145	3 (75)
599-09146	4 (100)
599-09147	5 (125)
599-09148	6 (150)

Dimensions

The letters in Figure 5 refer to actuator and service envelope dimensions in Table 11. See Table 12 for valve body dimensions.

**Table 11. Dimensions of the Actuator and Recommended Service Envelope.
Dimensions in Inches (Millimeters).**

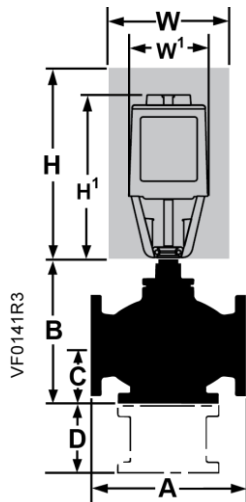

Figure 5.

Actuator	Actuator Prefix Code	Actual Height of Actuator H1	Service Height H	Actual width or diameter of Actuator W1	Service Width W
8" Pneumatic	277	14-1/8 (359)	26 (660)	8-3/4 (222) diameter	21 (533)
	278				
	283				
	284				
12" Pneumatic	279	17-7/8 (454)	30 (762)	15-1/8 (384) diameter	27 (686)
	281				
	285 287				
SKB/C with handle closed	289	14-3/4 (375)	22-3/4 (578)	7 (178) Width x 8-15/16 (226) Depth	25 (635)
	290				
	291				
	292				
	293 294				
SKD	267	11-13/16 (300)	19-3/4 (500)	5 (127) Width x 6-5/8 (169) Depth	14-1/2 (360)
	274				
	275				
	276				

Table 12. Valve Dimensions and Weight.

Nominal Valve Size Inches (mm)	Dimensions in Inches (Millimeters)					Weight	
	A		B	C	D	lbs. (kg)	
	ANSI Class 125	ANSI Class 250				ANSI Class 125	ANSI Class 250
2-1/2 (65)	10-7/8 (276.4)	11-1/2 (292)	9-3/8 (239.2)	3-3/4 (95)	6-1/2 (165)	50 (23)	63 (29)
3 (80)	11-3/4 (298.5)	12-1/2 (318)	10-3/4 (272)	4-3/8 (111)	7 (178)	65 (30)	82 (37)
4 (100)	13-7/8 (352.4)	14-1/2 (368)	12-1/2 (317.6)	5-1/8 (131.6)	7-1/2 (191)	110 (50)	134 (61)
5 (125)	15-3/4 (400)	16-5/8 (422)	13-3/4 (349.2)	5-3/4 (146.2)	8-1/2 (216)	136 (62)	176 (80)
6 (150)	17-3/4 (451)	18-5/8 (473)	15-1/2 (393)	6-5/8 (167)	9-1/2 (241)	141 (64)	258 (117)

Parts List

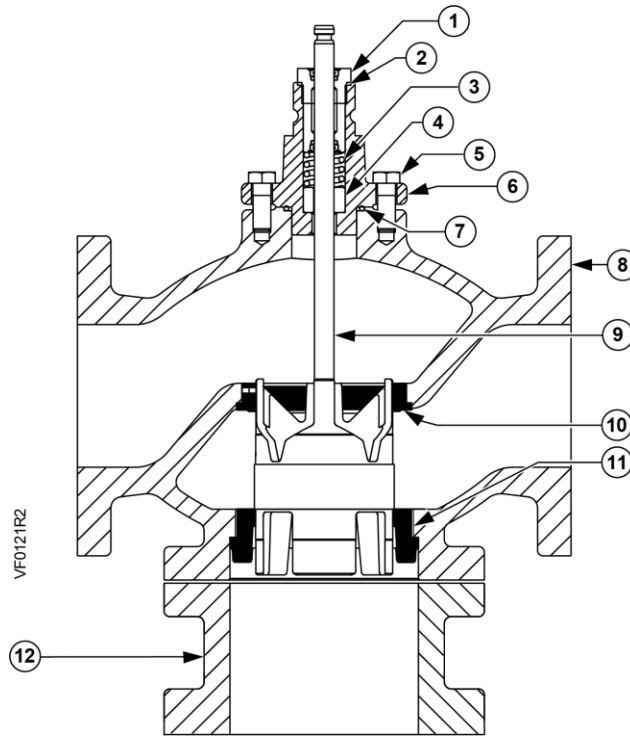

Table 13. Parts List for Three-Way Flanged Valves.

Item	Part Name	Order Number	Quantity	Material
1	Packing Cartridge Assembly	–	1	–
2	Gasket	–	1	Copper
3	Packing Spring	–	1	Stainless steel
4	Packing Bearing	–	1	Bronze
5	Cap Screw	–	4	Plated steel
6	Bonnet	–	1	Cast iron
7	O-ring	–	1	EP
8	Valve Body	–	1	Cast Iron
9	Stem and Plug Assembly	–	1	Bronze or stainless steel
10	Upper Seat	–	1	Bronze or stainless steel
11	Lower Seat	–	1	Bronze or stainless steel
12	Service Flange	See Table 3.	(Optional)	Cast iron
	Packing Kit	599-08020	–	Items 1 and 2
	Rebuild/Repack Kit	See Table 2.	–	Items 1, 2, 3,4, 7, and 9

Information in this publication is based on current specifications. The company reserves the right to make changes in specifications and models as design improvements are introduced. Flowrite is a trademark of Siemens Industry, Inc. Other product or company names mentioned herein may be the trademarks of their respective owners. © 2019-2023 Siemens Industry, Inc.